

DRAWING KEY

FOLD TYPES



A - FOLD (ABOVE)



B - FOLD (BESIDE)



C



C - FOLD (COVER)



LINE TYPE/COLOR

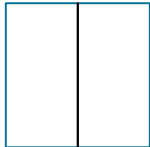

CUT



50% SCORE

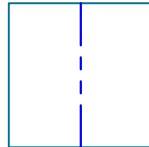

CREASE

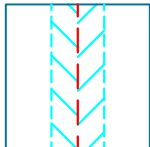

45° DOUBLE BEVEL

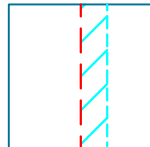

45° SINGLE BEVEL

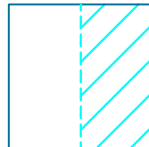

EDGE BEVEL

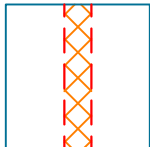

CAVITY

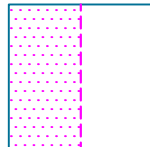

REMOVE PAPER

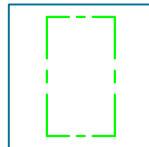

REFERENCE/
OPTIONAL



SYMBOLS

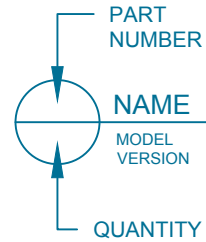

MIRRORED PART

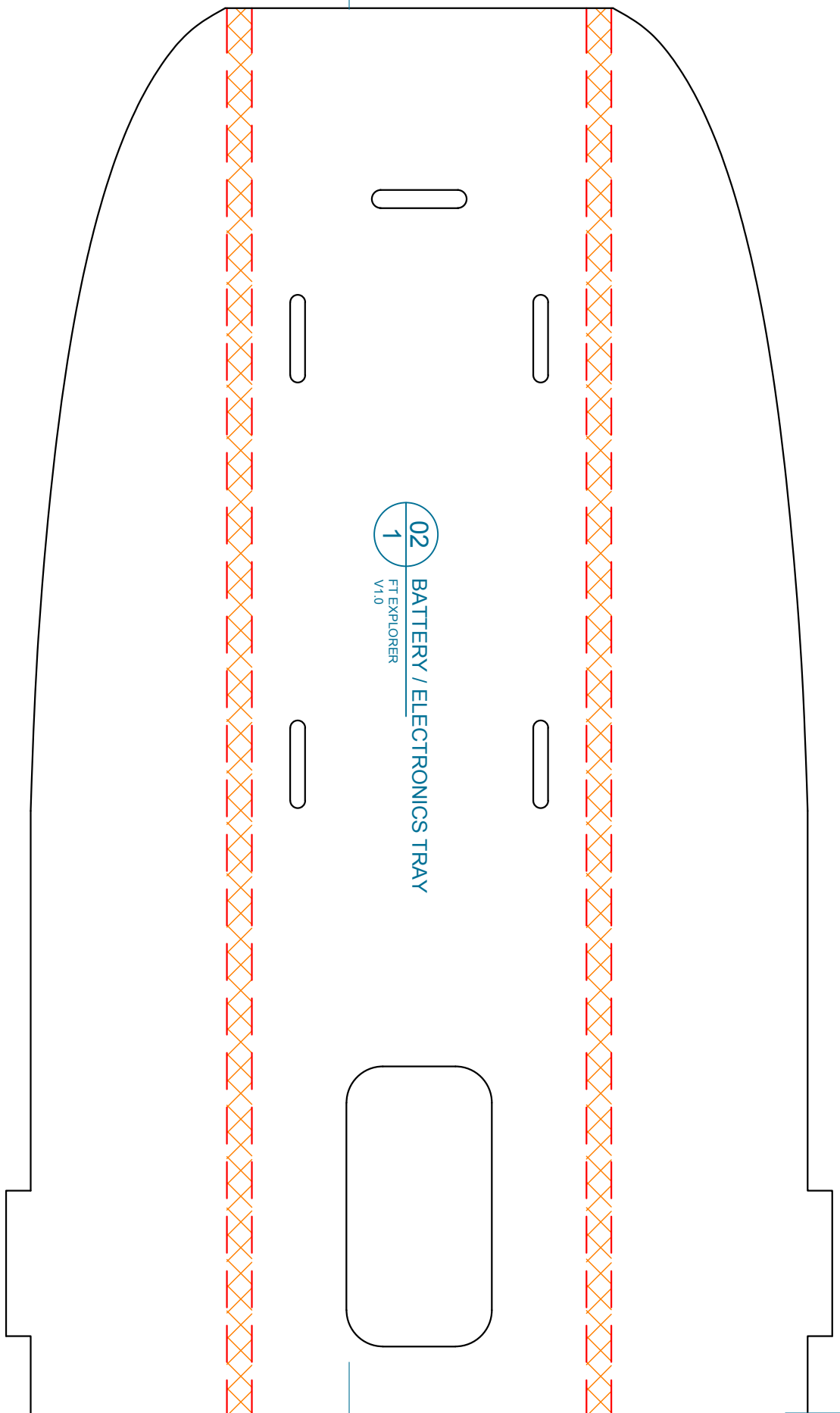

02 BATTERY / ELECTRONICS TRAY
1 FT EXPLORER
V1.0



16
1
FT EXPLORER
V1.0
VERTICAL STABILIZER

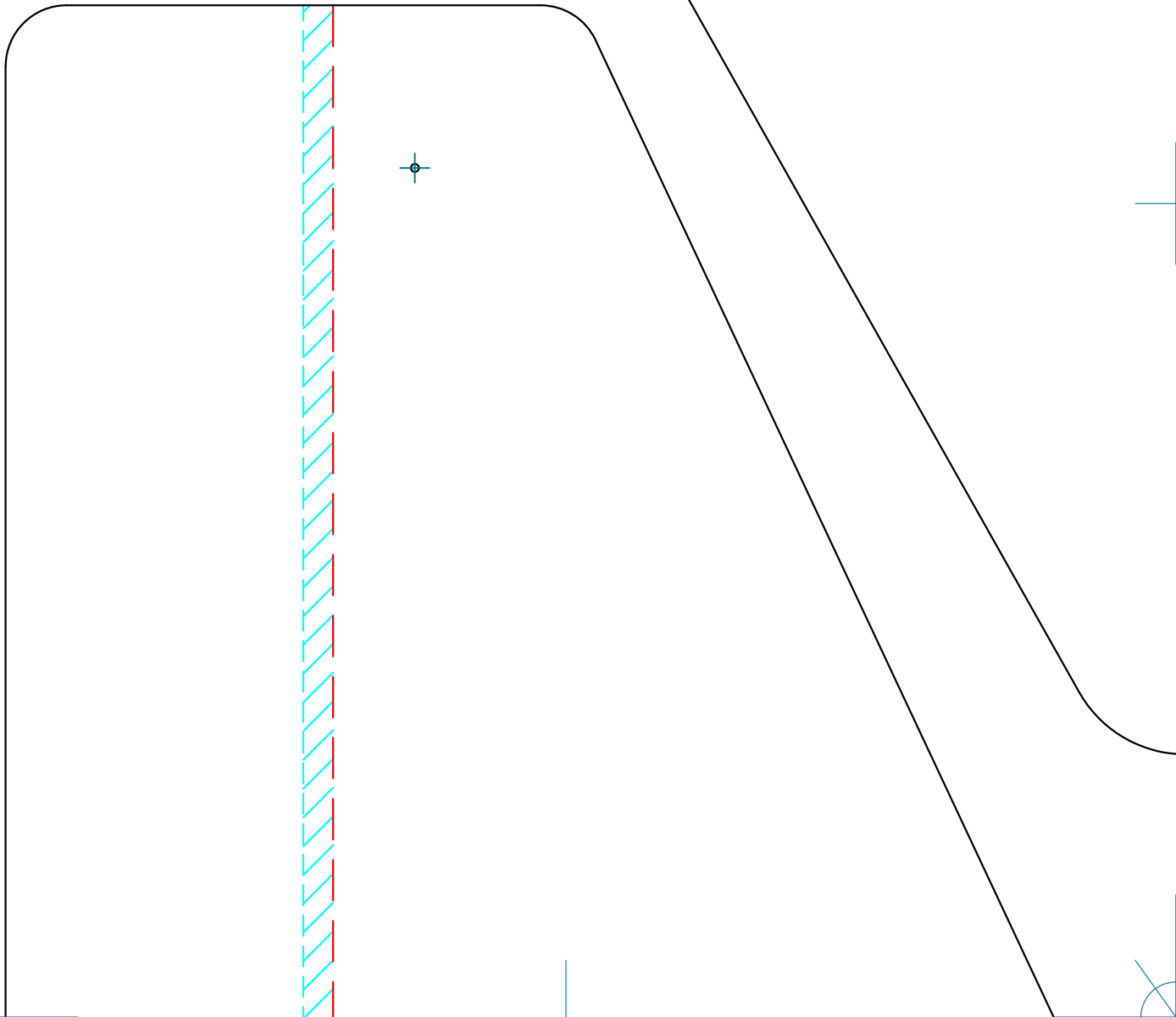

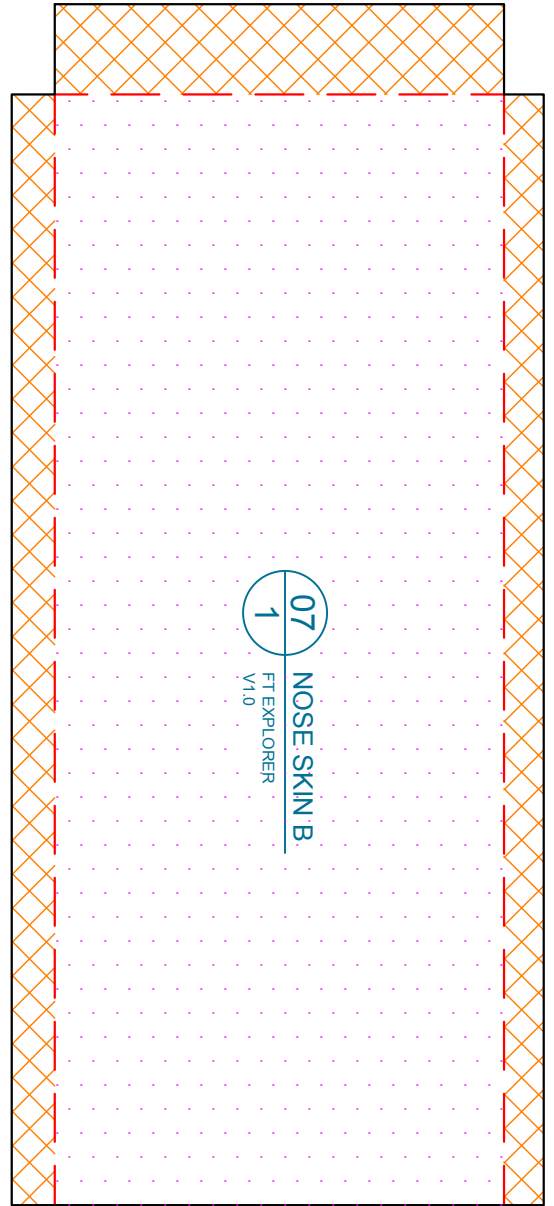
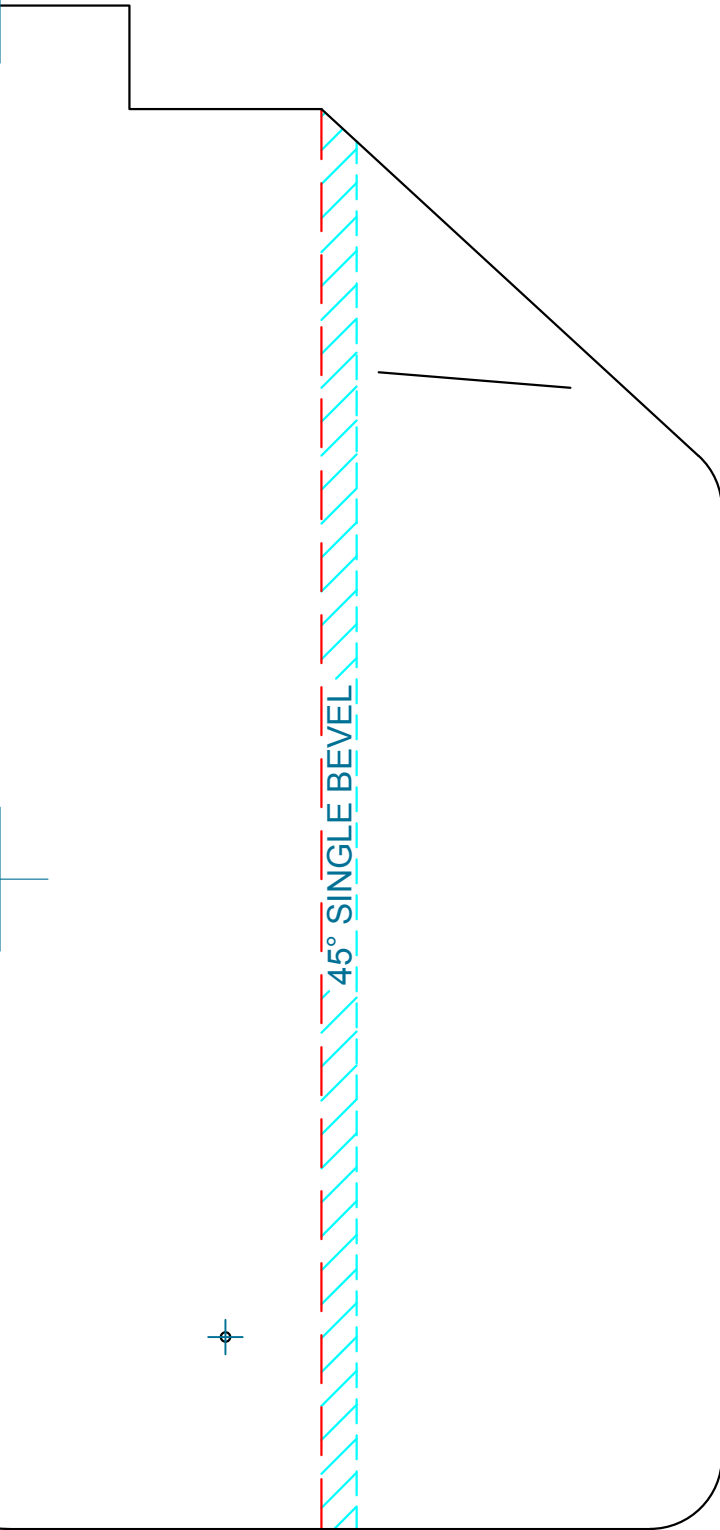

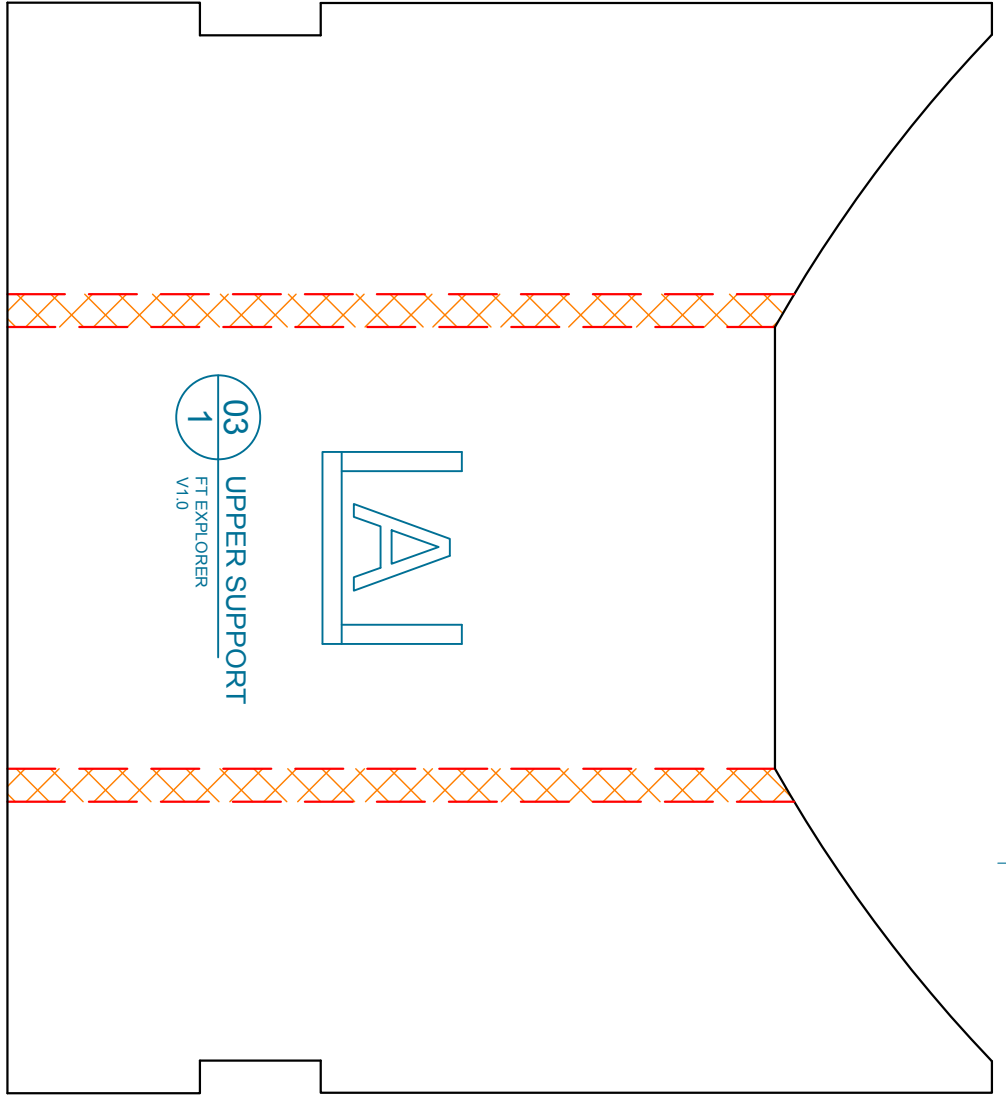

03
1
FT EXPLORER
V1.0
UPPER SUPPORT

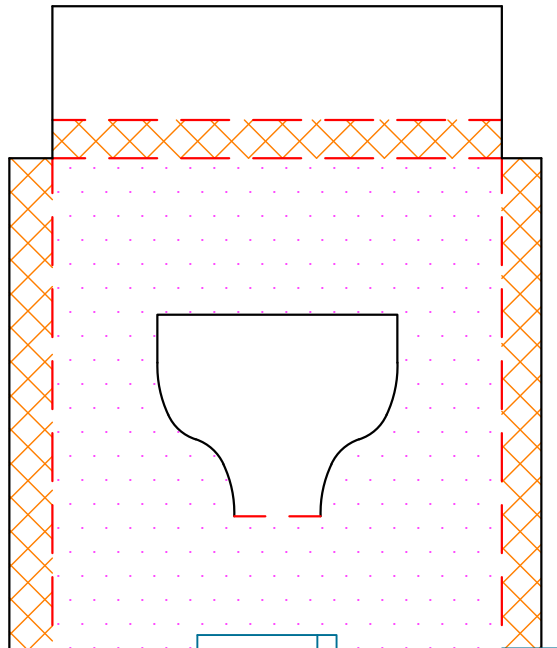
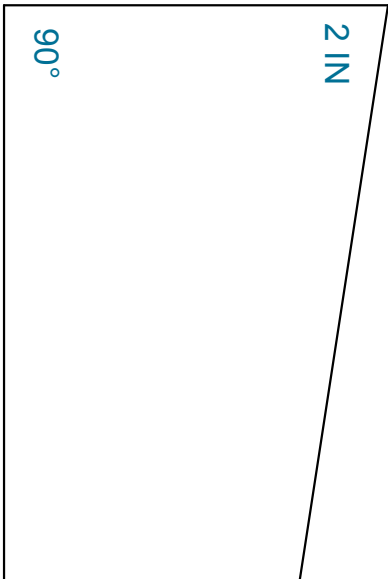

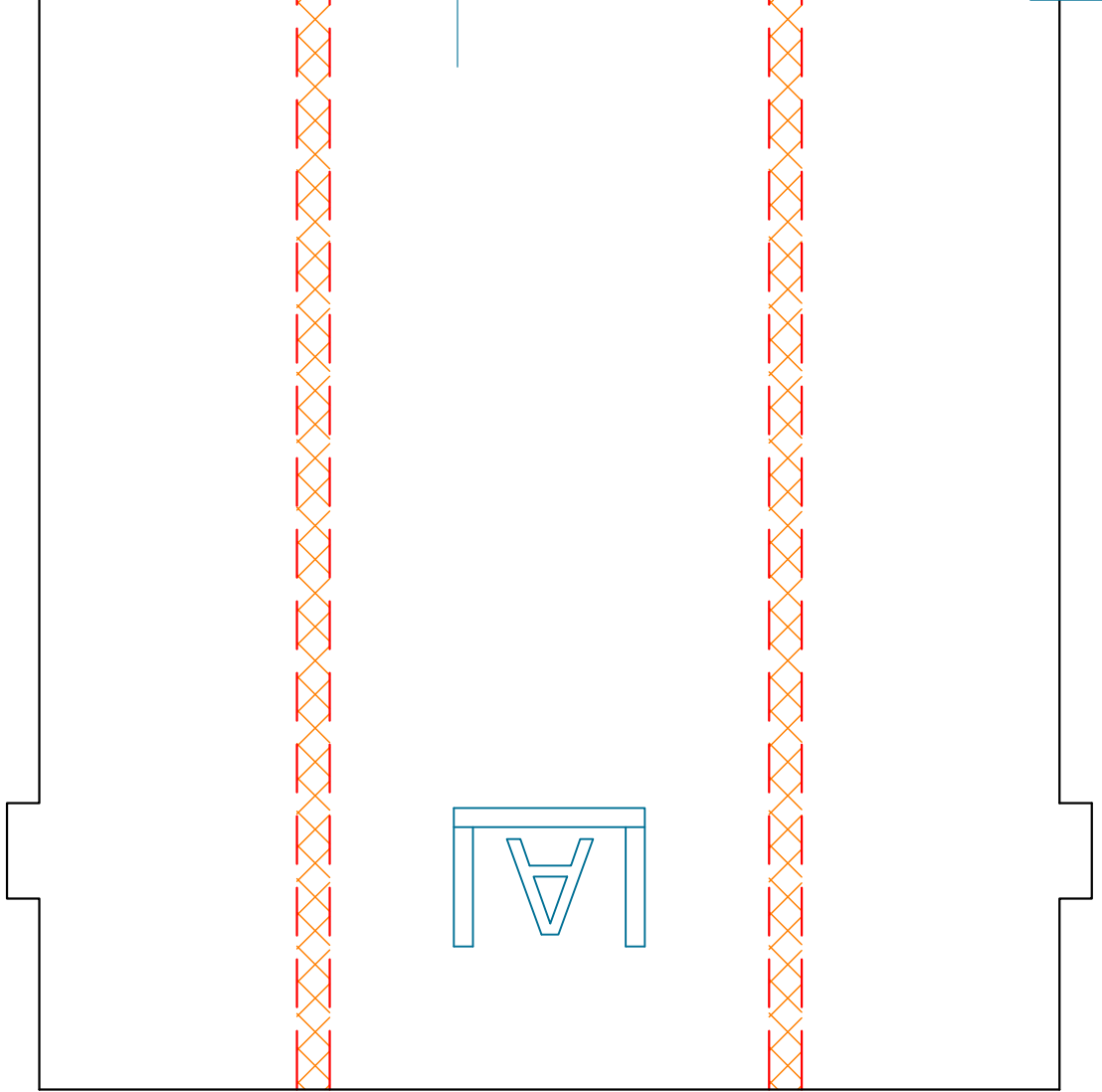

15
1

HORIZONTAL STABILIZER
FT EXPLORER
V1.0

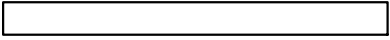

45° SINGLE BEVEL



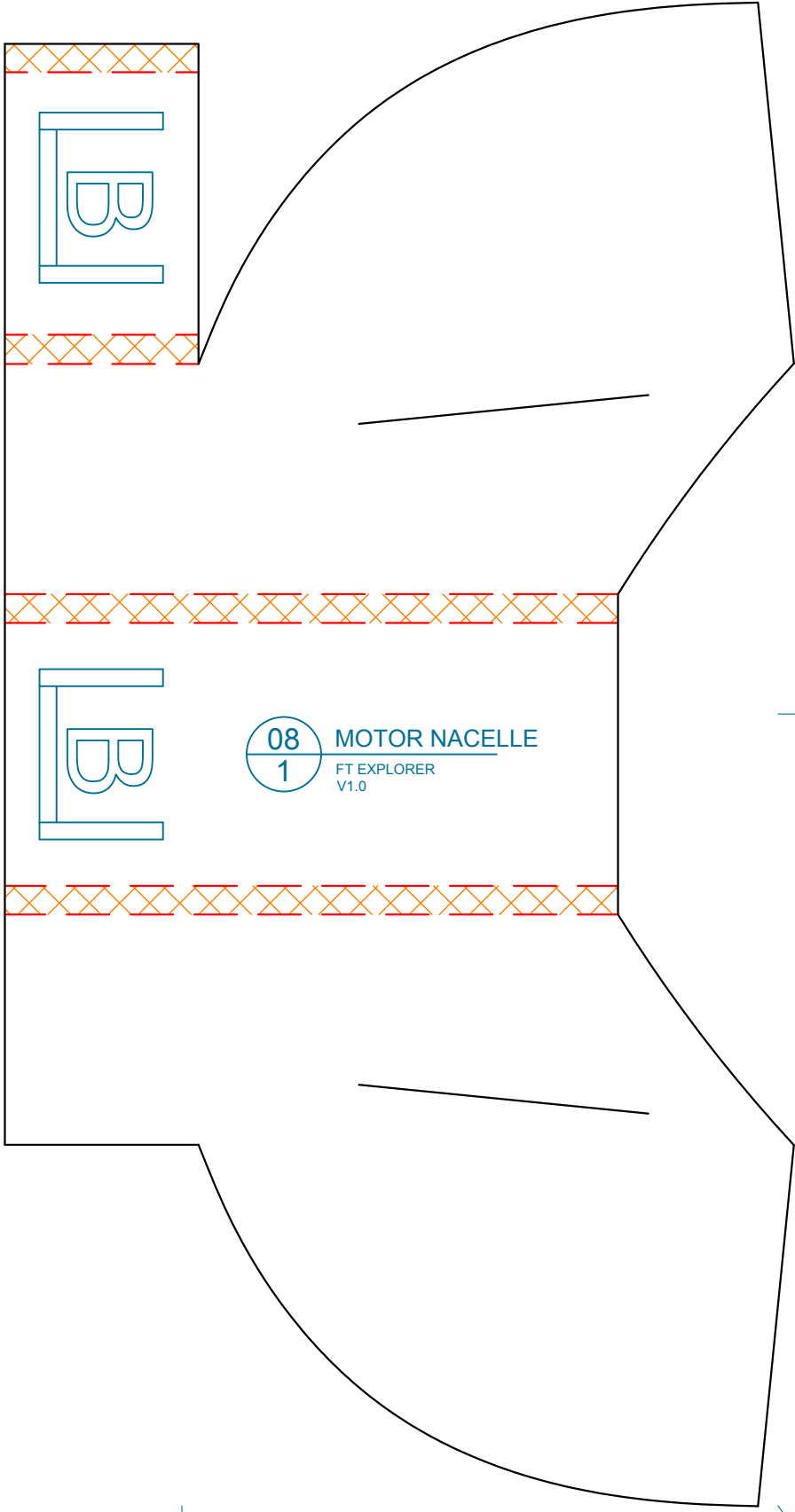
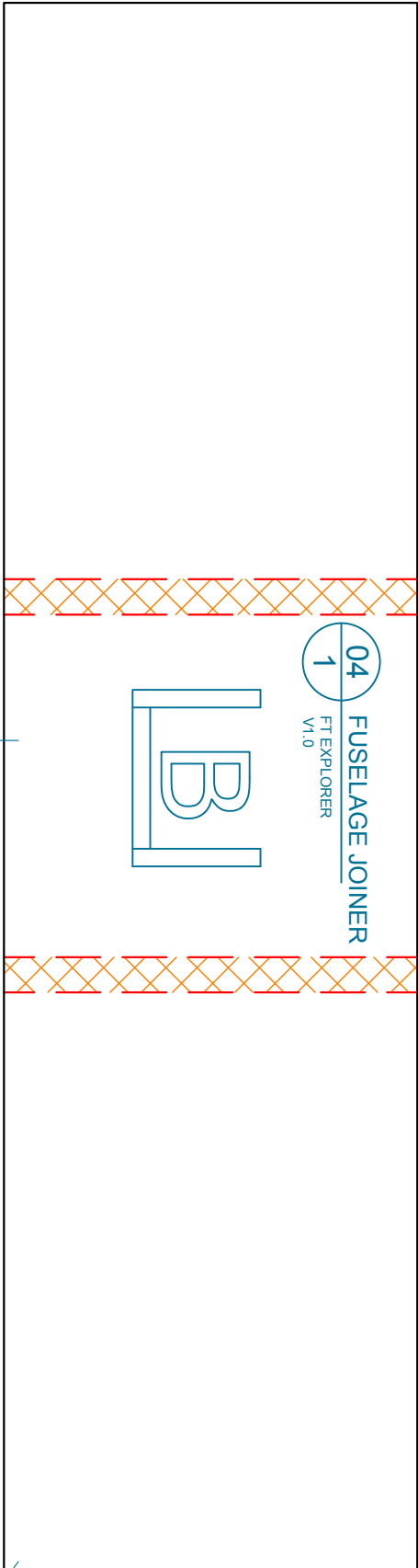

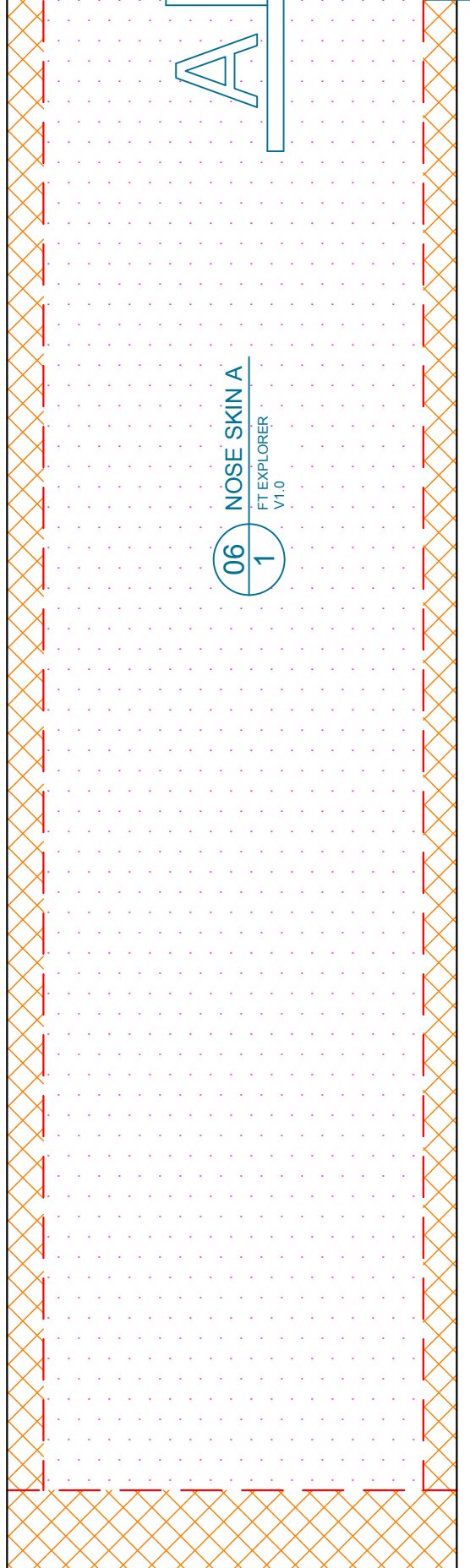
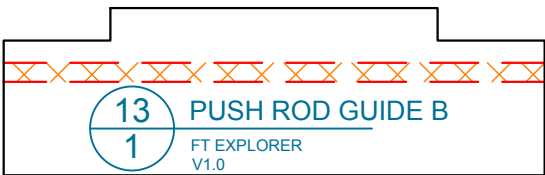
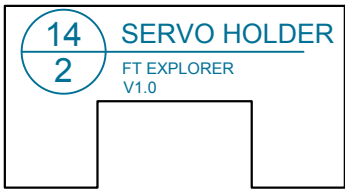
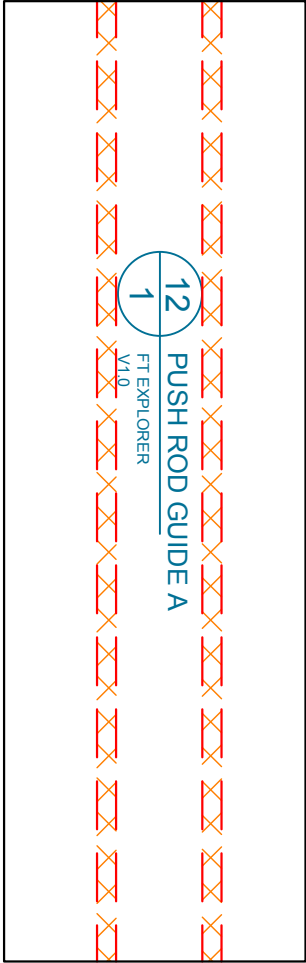

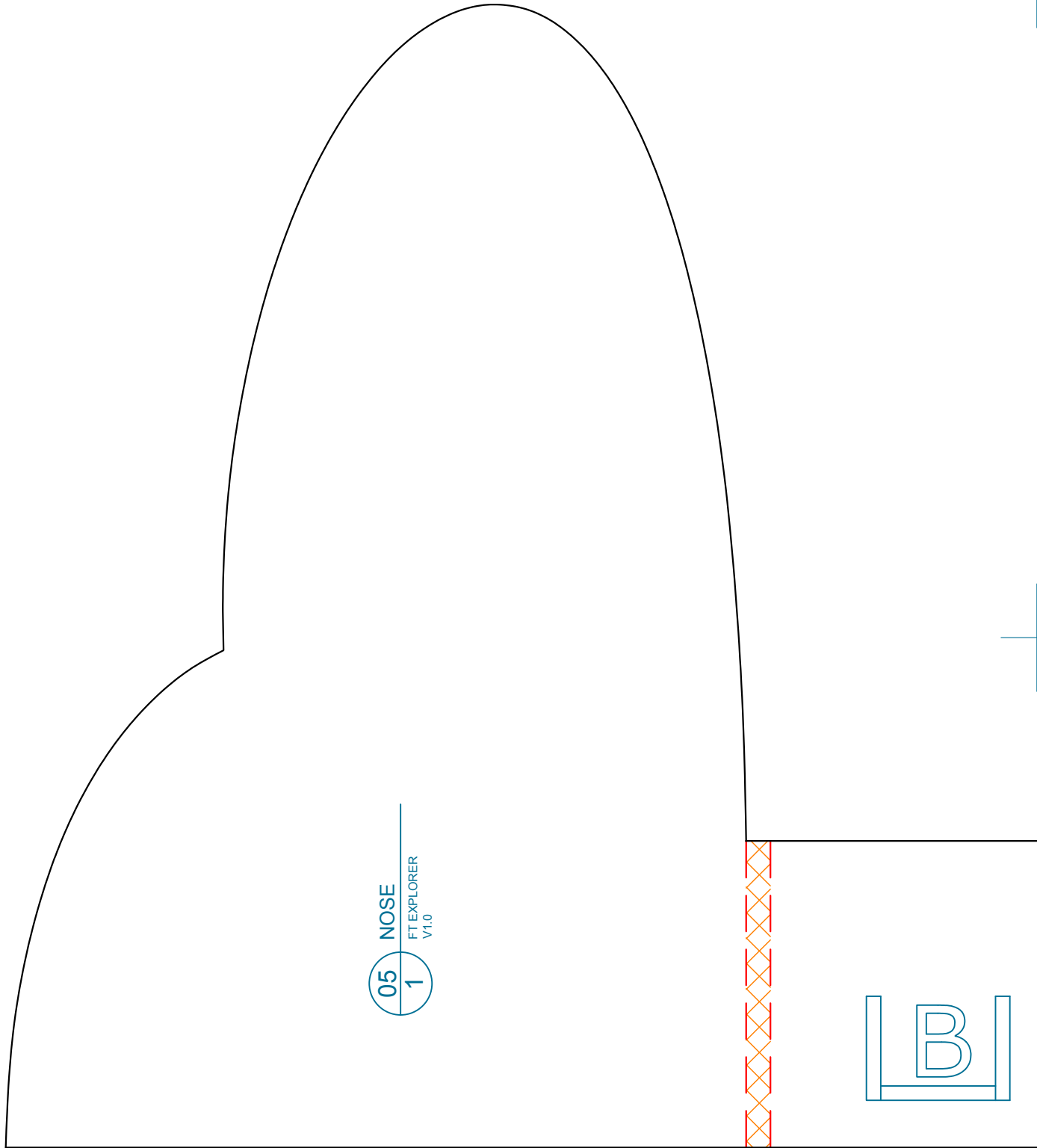

05 NOSE
1 FT EXPLORER
V1.0

LBI

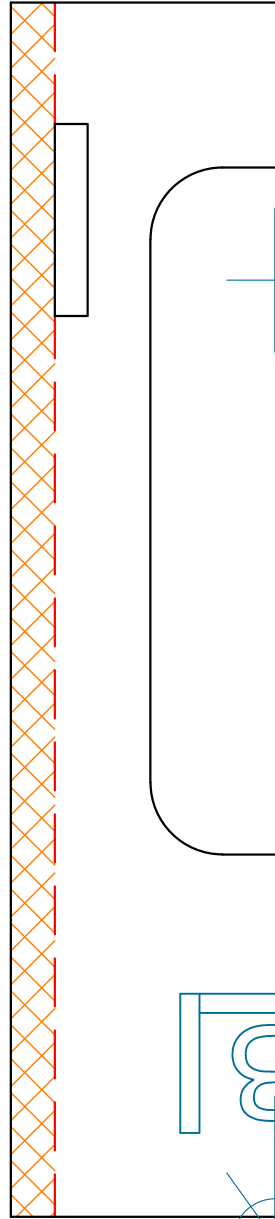
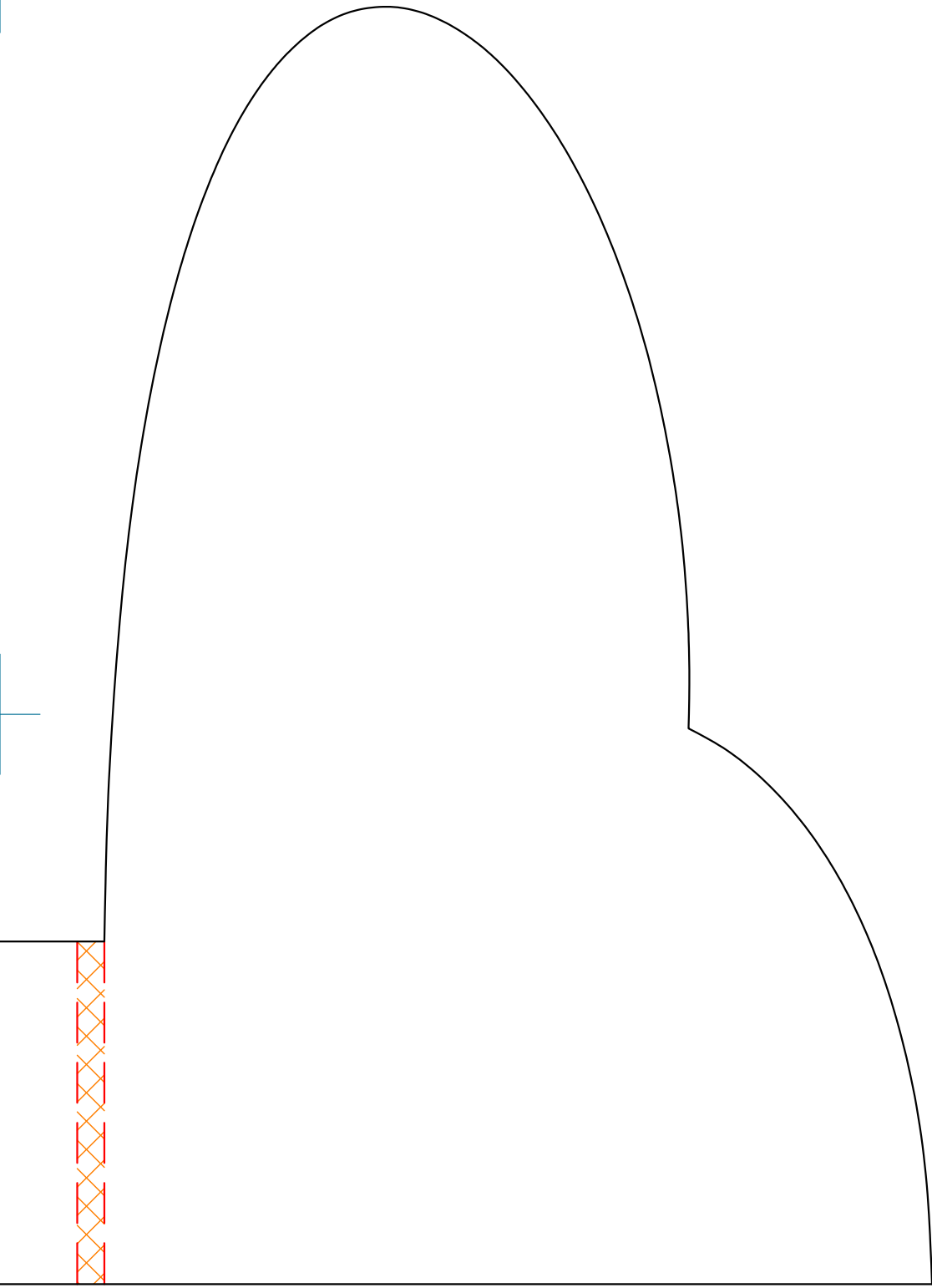

B

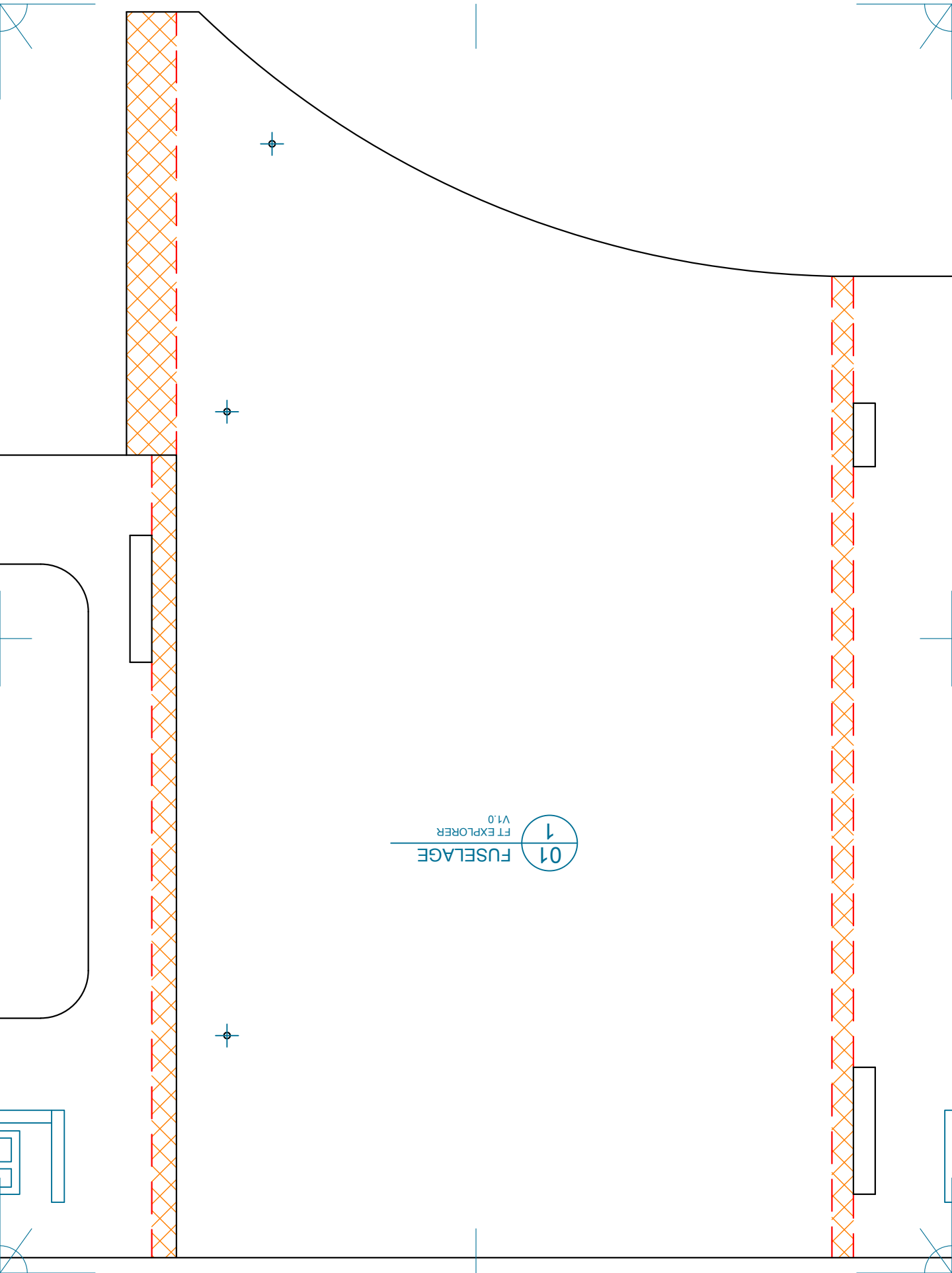

01
FUSELAGE
FT EXPLORER
V1.0

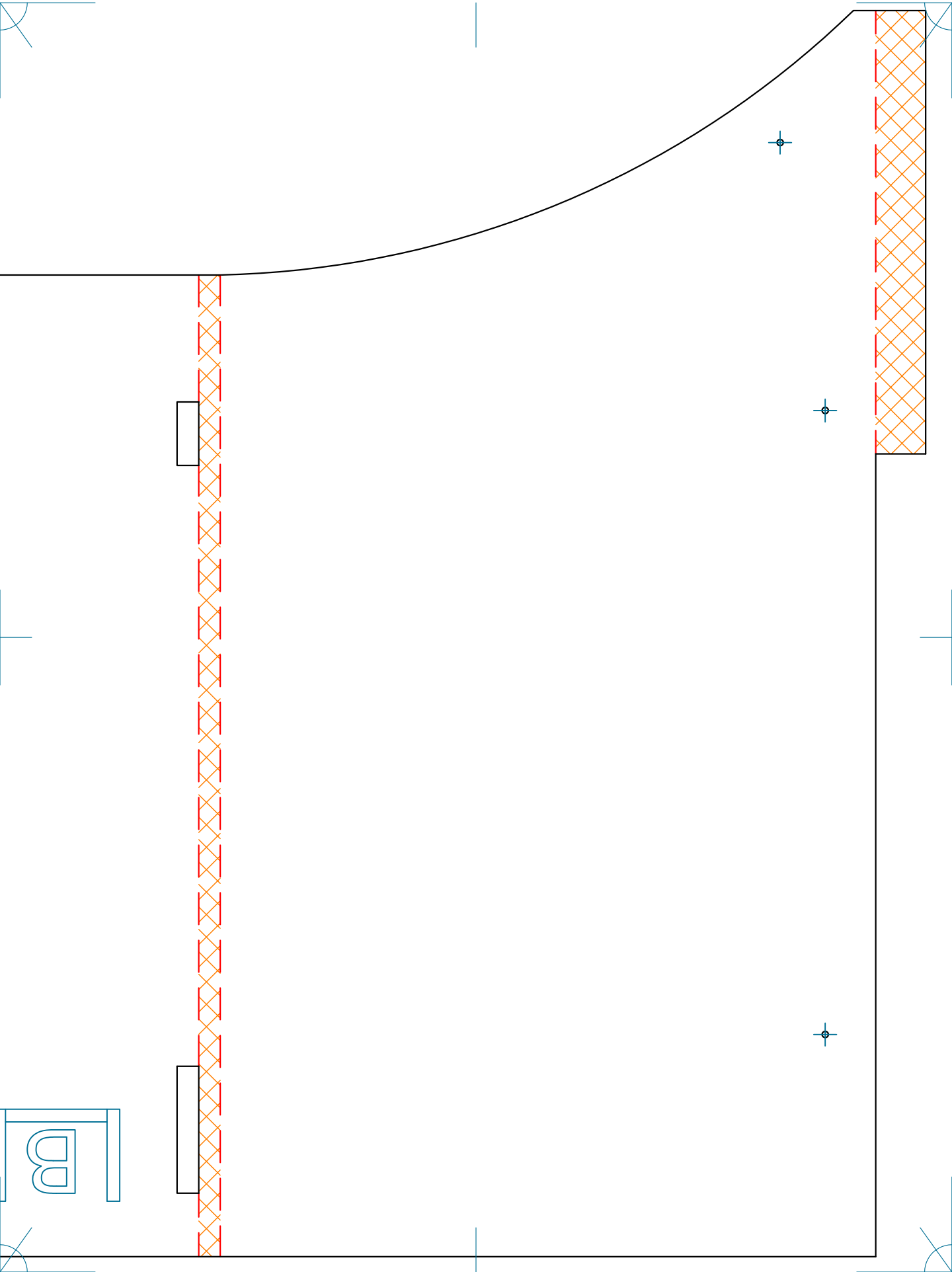

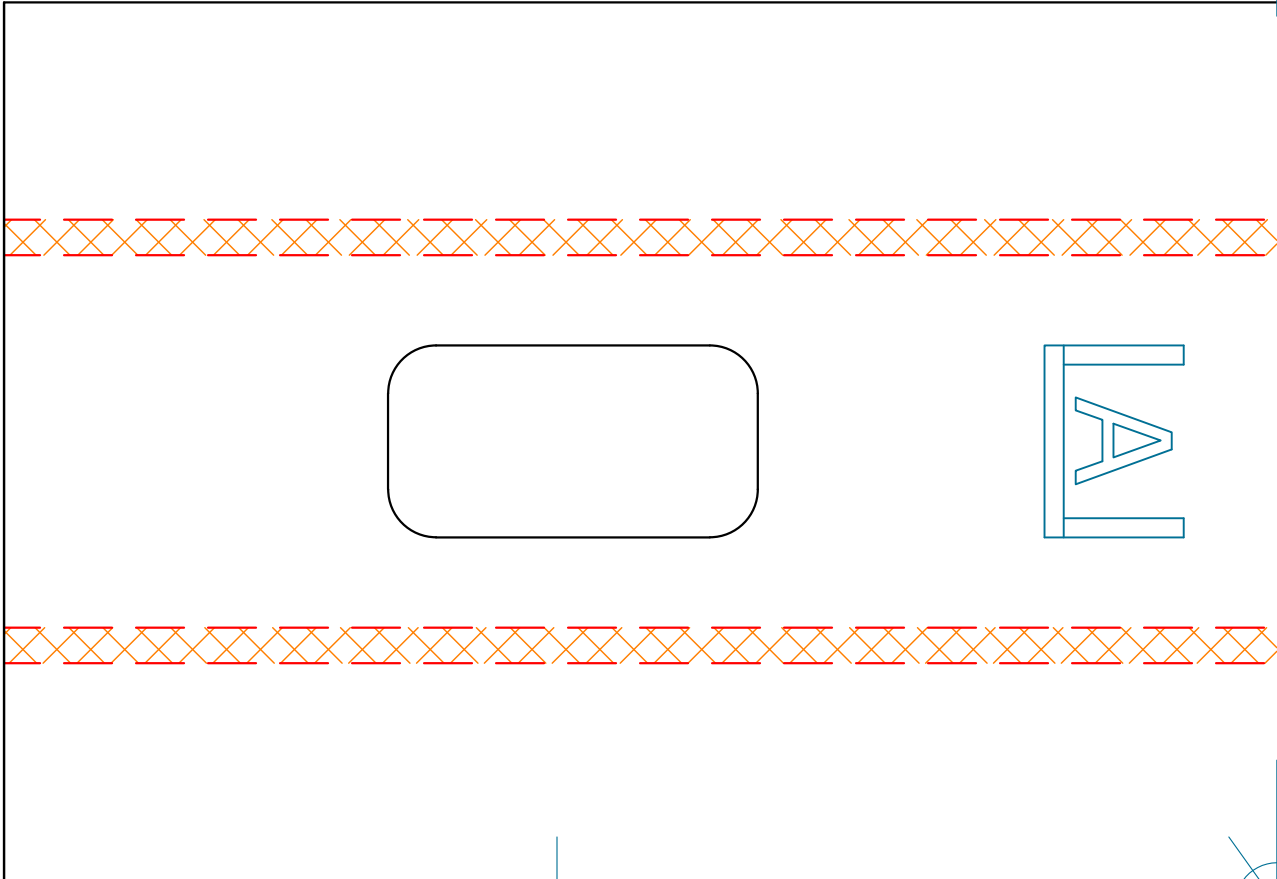
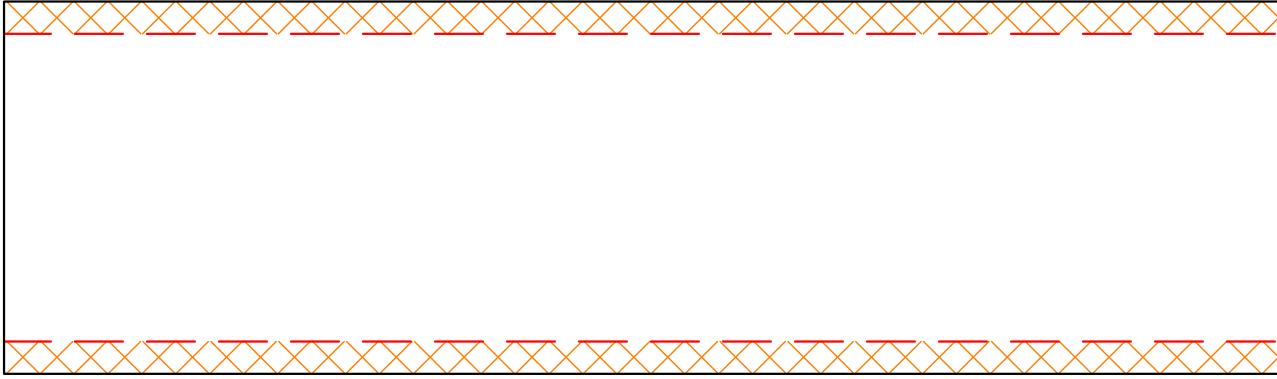

11
1

TAIL BOOM BOTTOM

FT EXPLORER
V1.0

10
1

TAIL BOOM

FT EXPLORER
V1.0

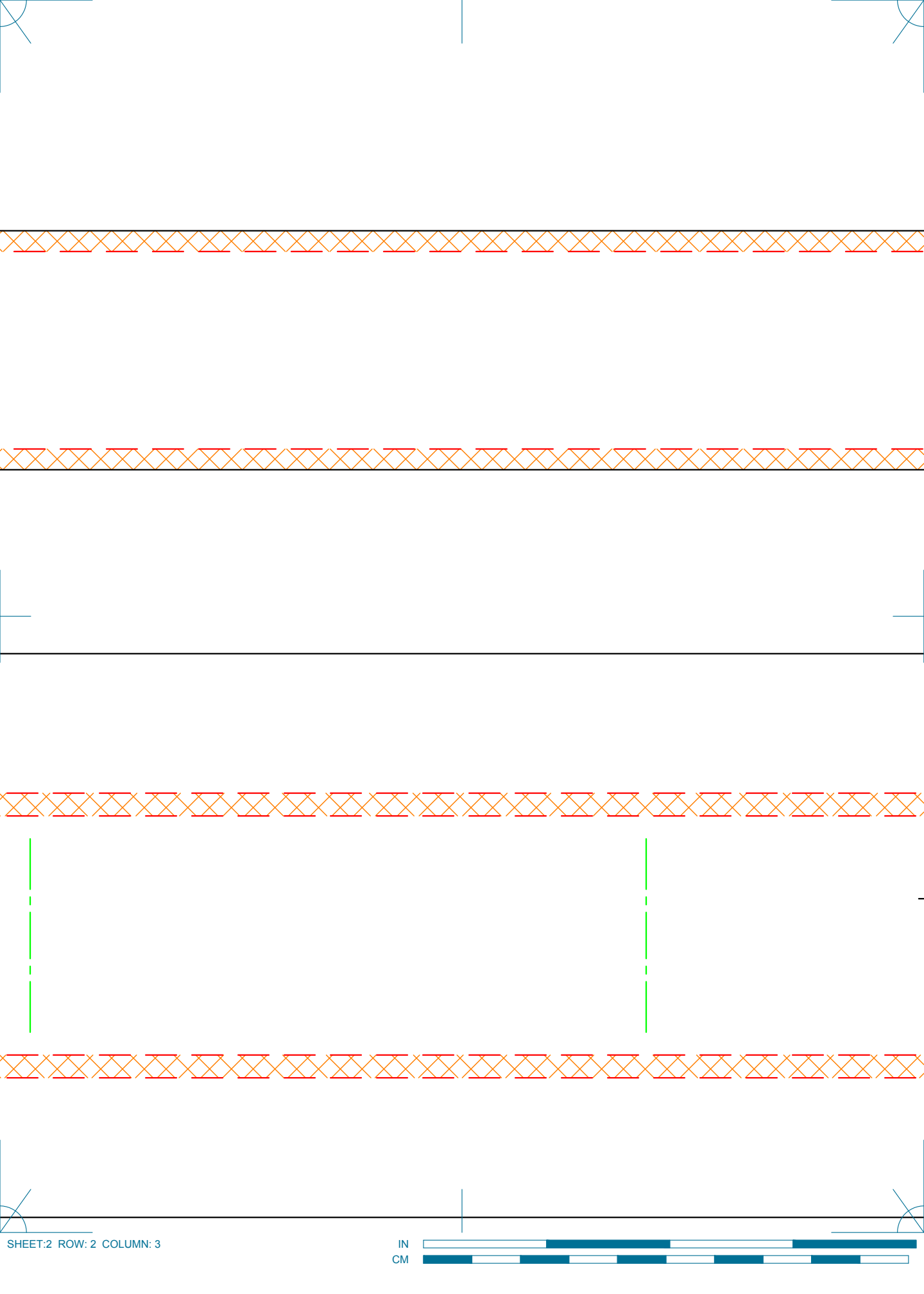

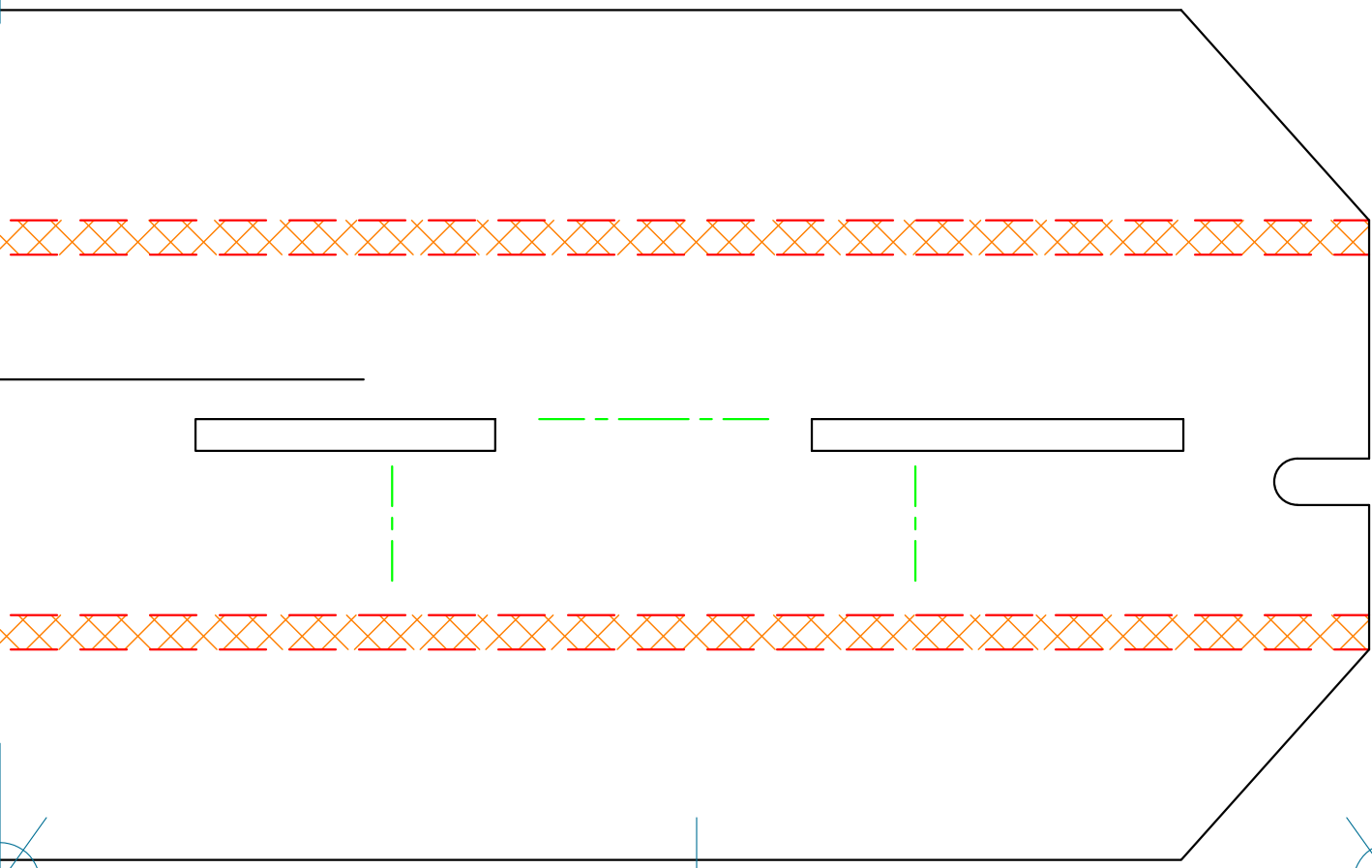
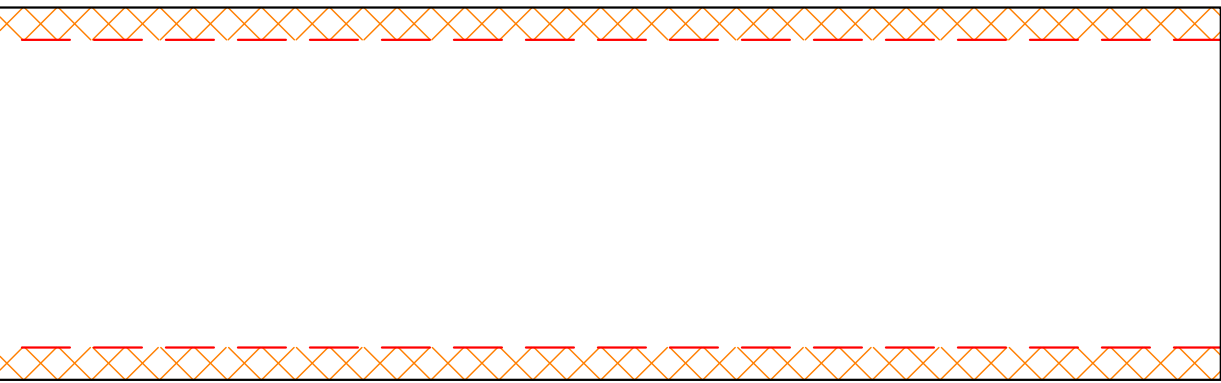

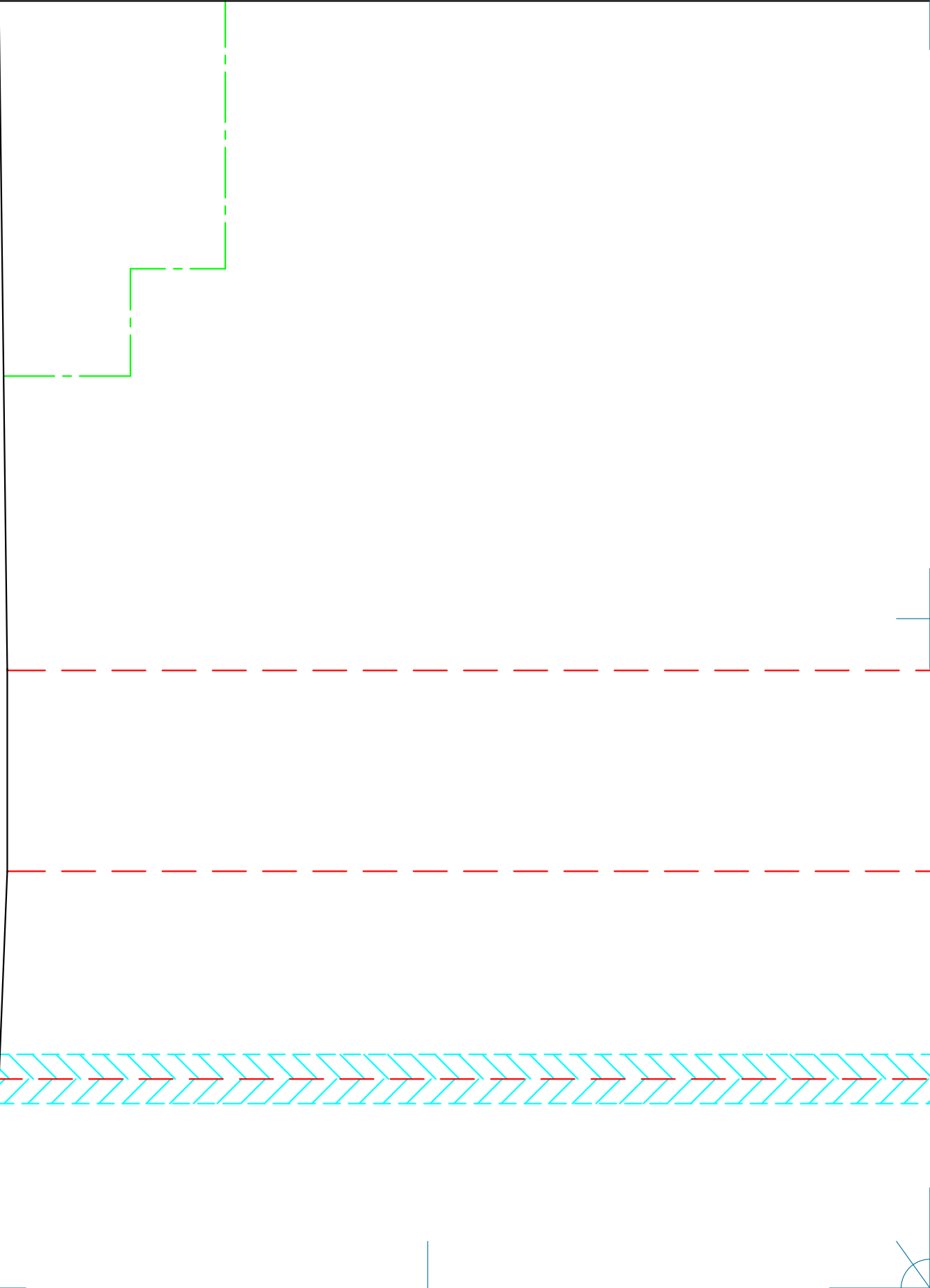

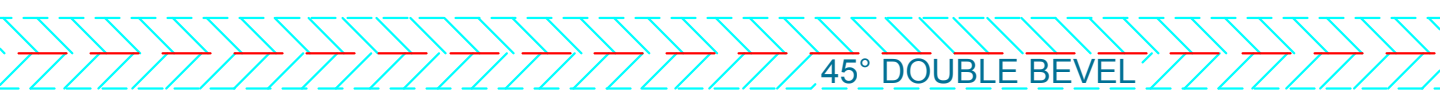

45° DOUBLE BEVEL

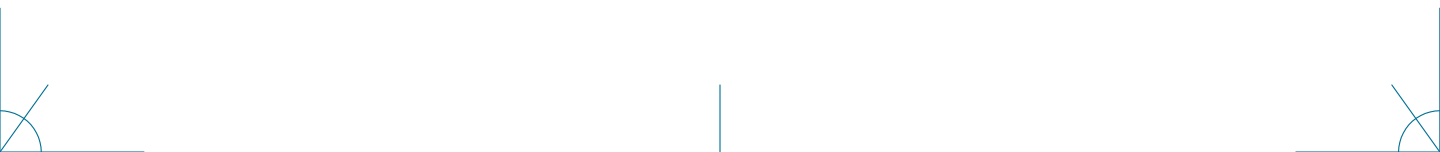

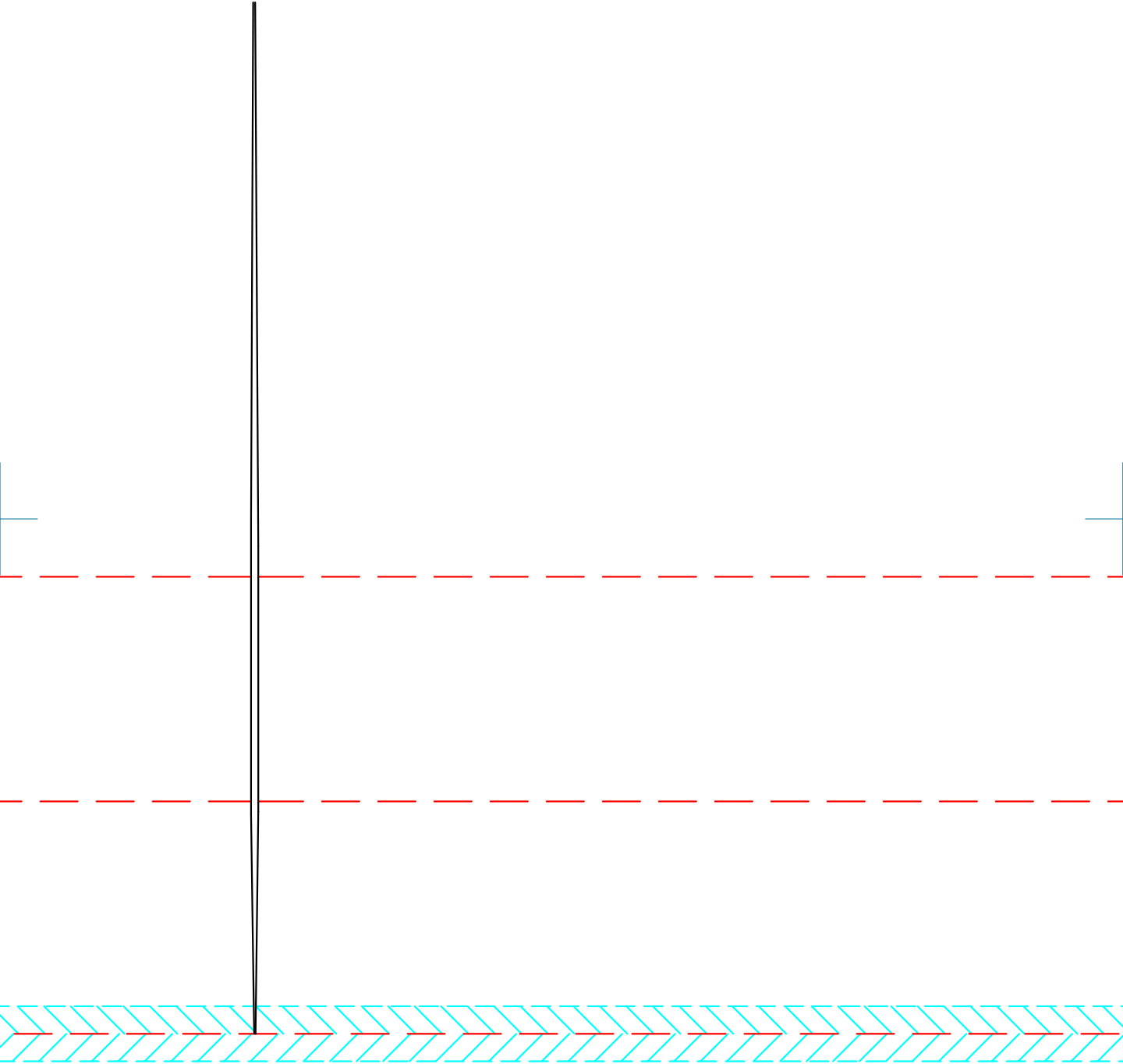

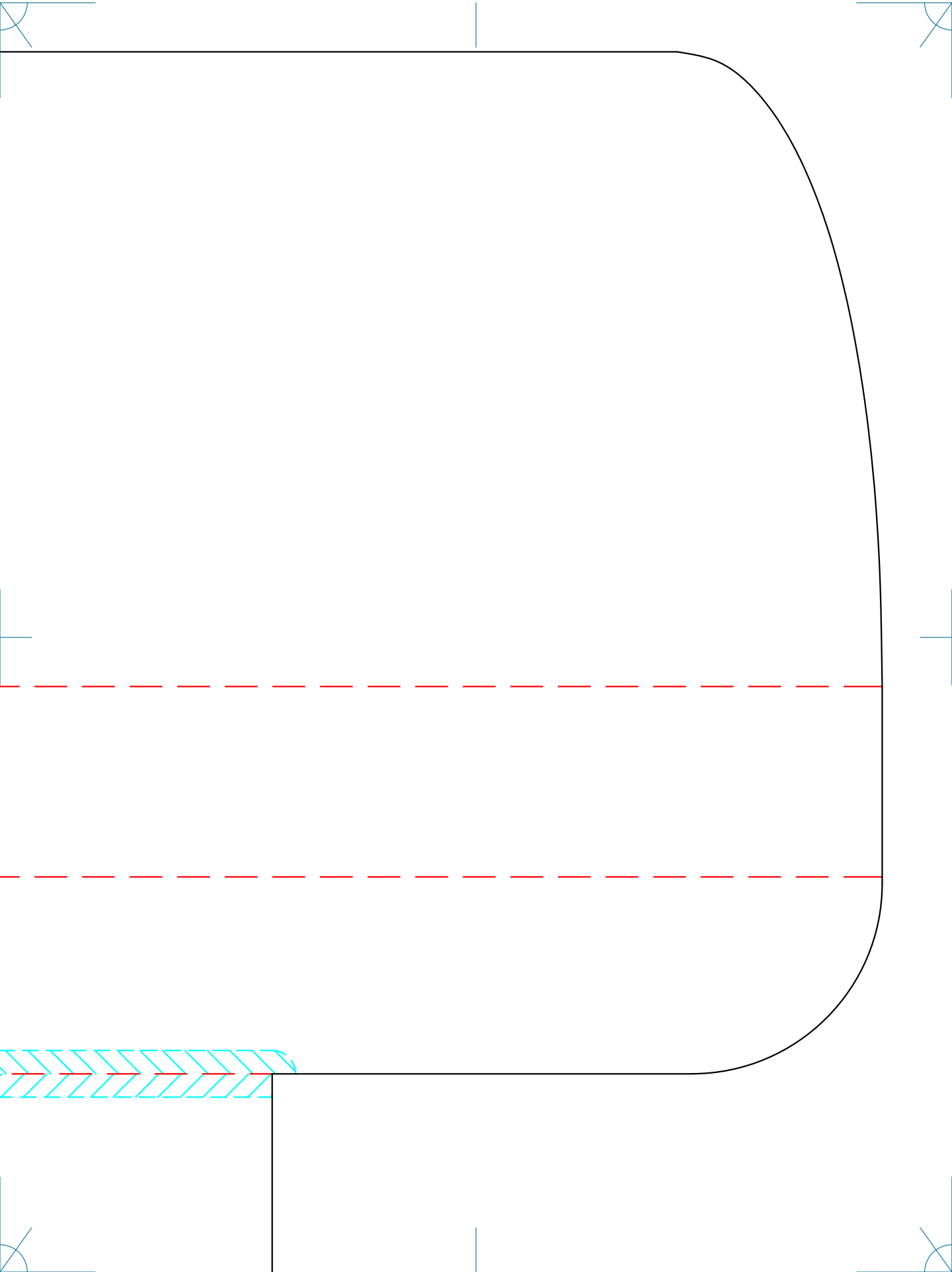



18 WING SPAR B (TRAINER
1 FT EXPLORER
V1.0

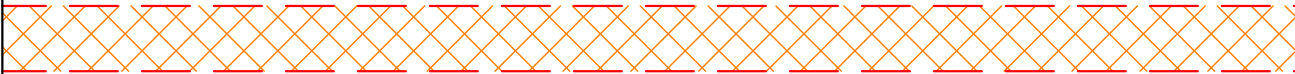



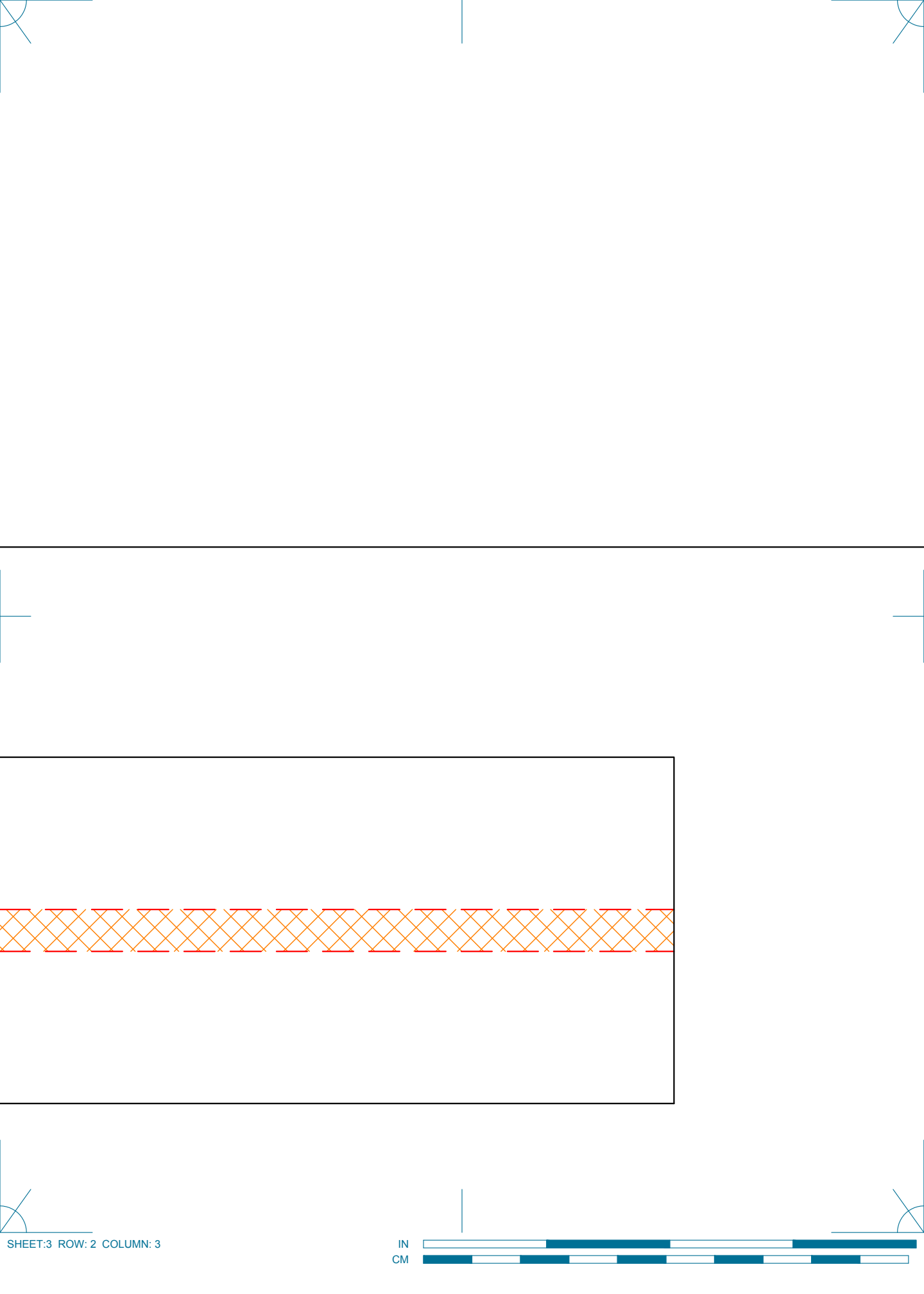

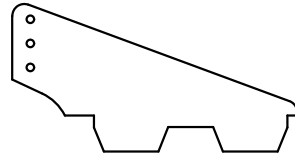

CONTROL HORN
1/16" (1.5mm) THICK
HOBBY GRADE PLYWOOD

FT ELEMENTS SIMPLE FIREWALL
3/32" (2.4 mm) THICK HOBBY GRADE PLYWOOD

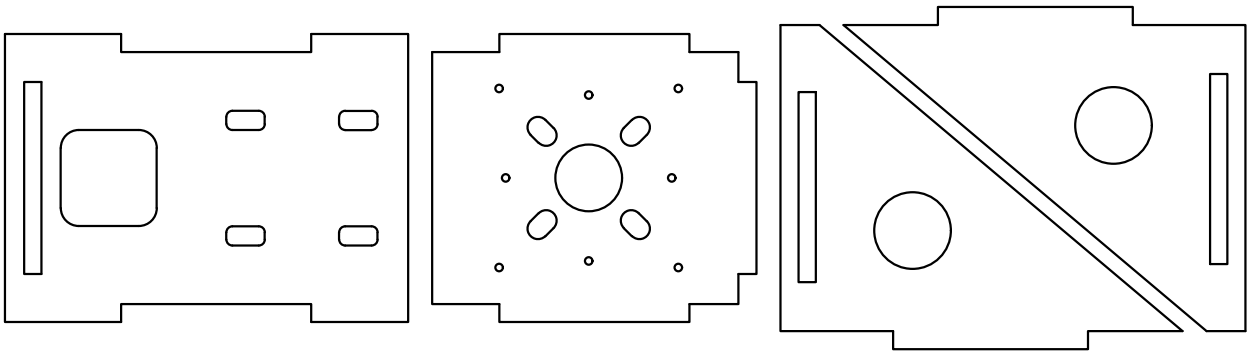

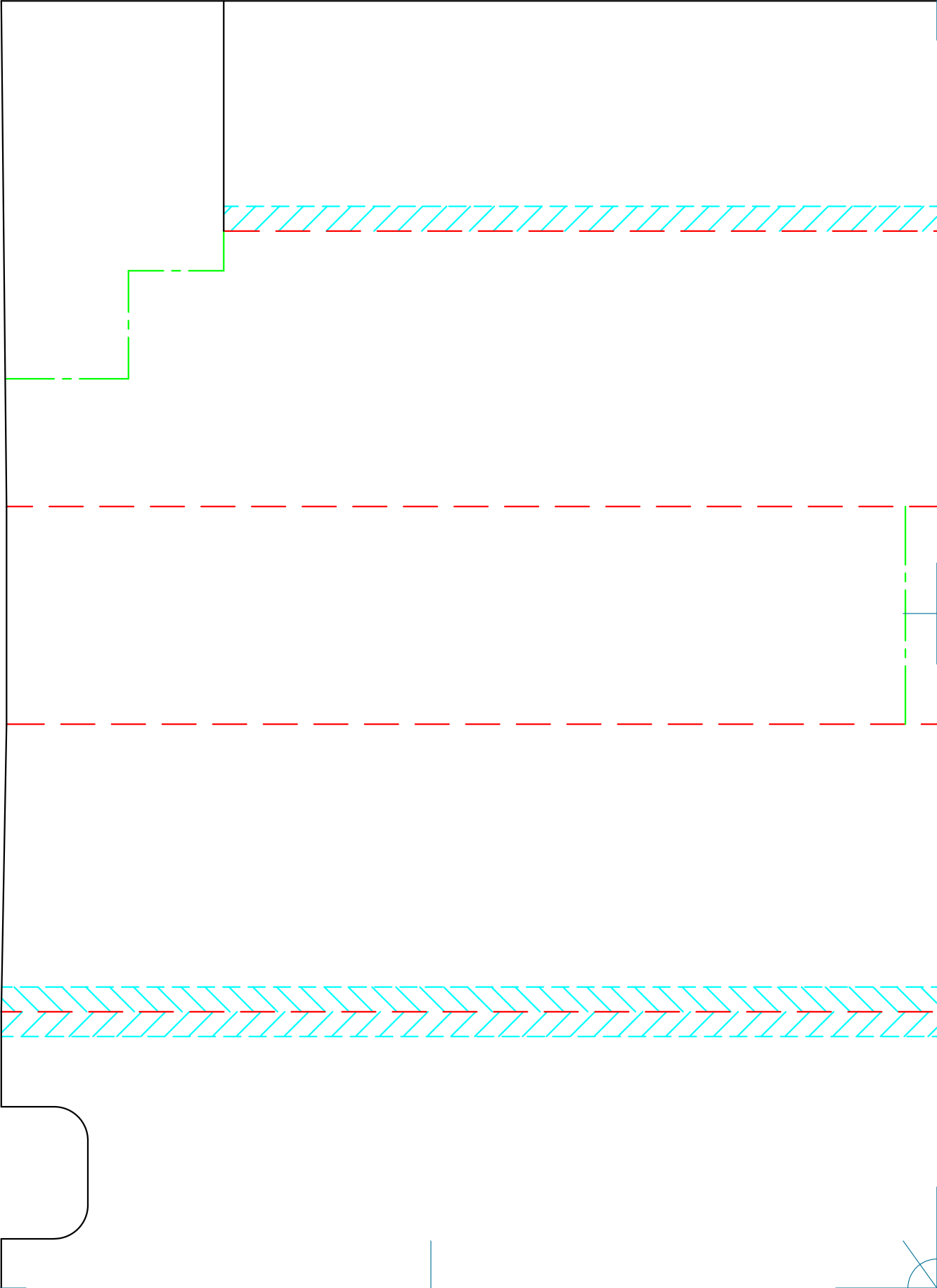

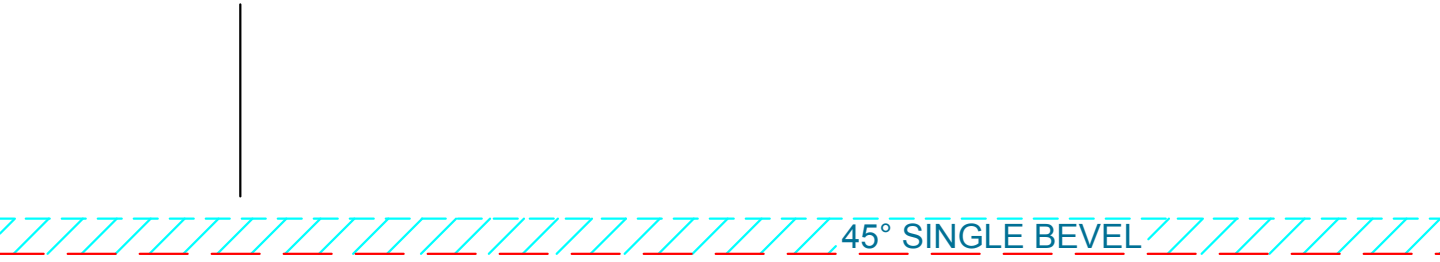

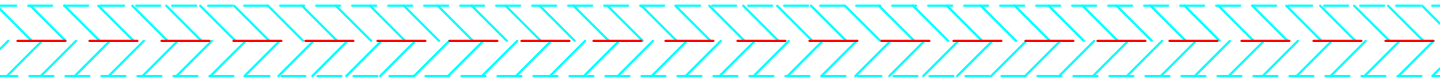
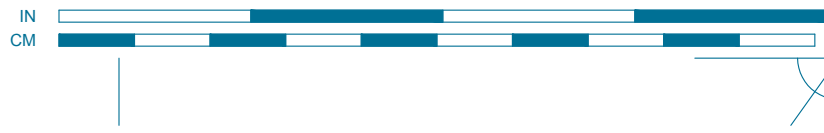

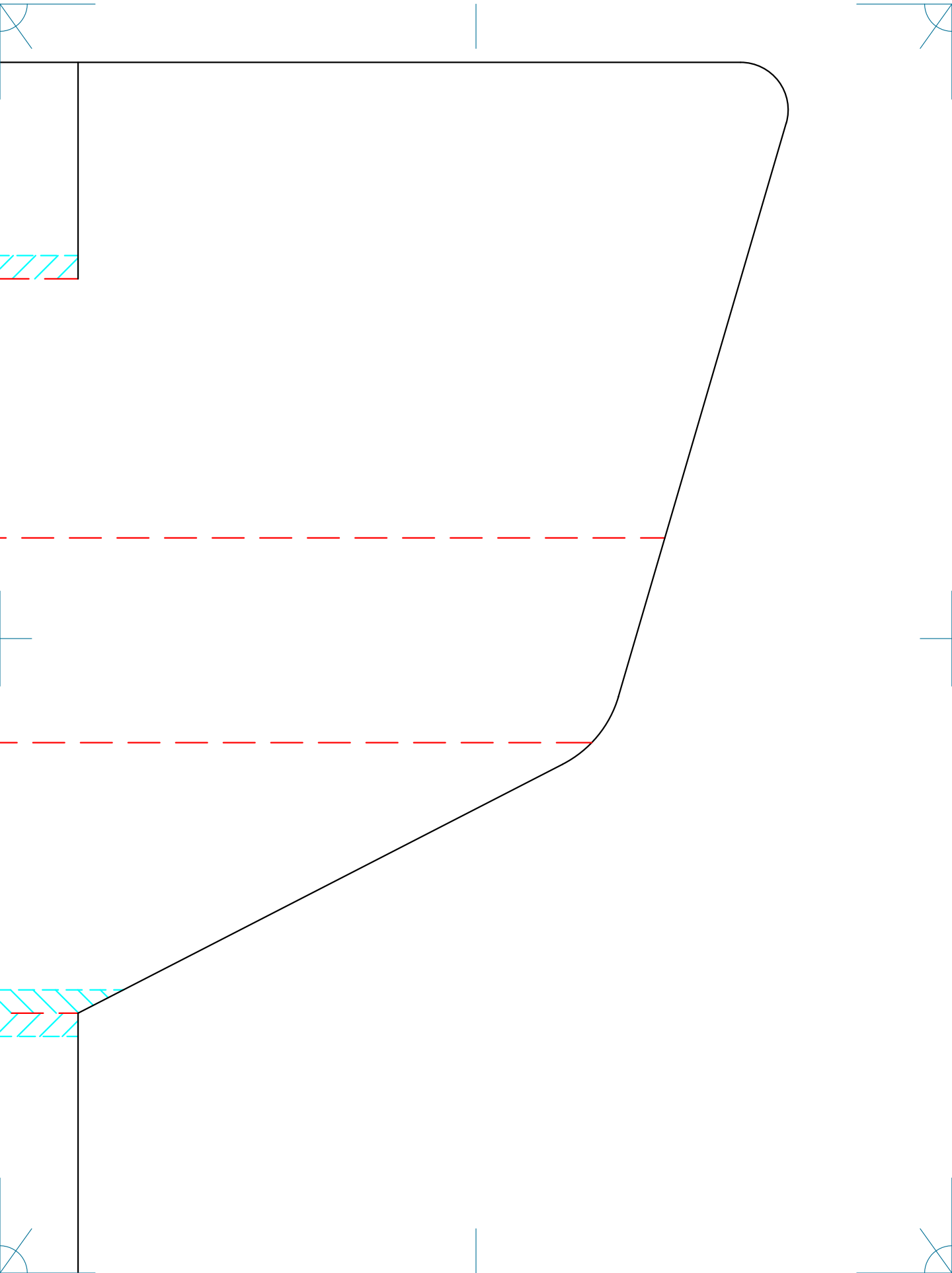

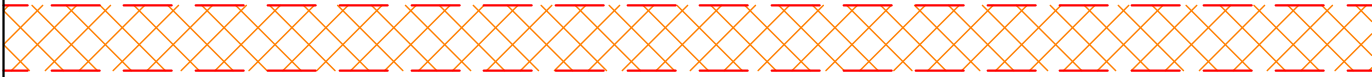
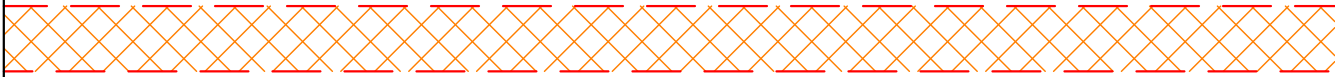

17 WING SPAR A
2 FT EXPLORER
V1.0





21 SPORT WING
2 FT EXPLORER
V1.0

1L | 1R



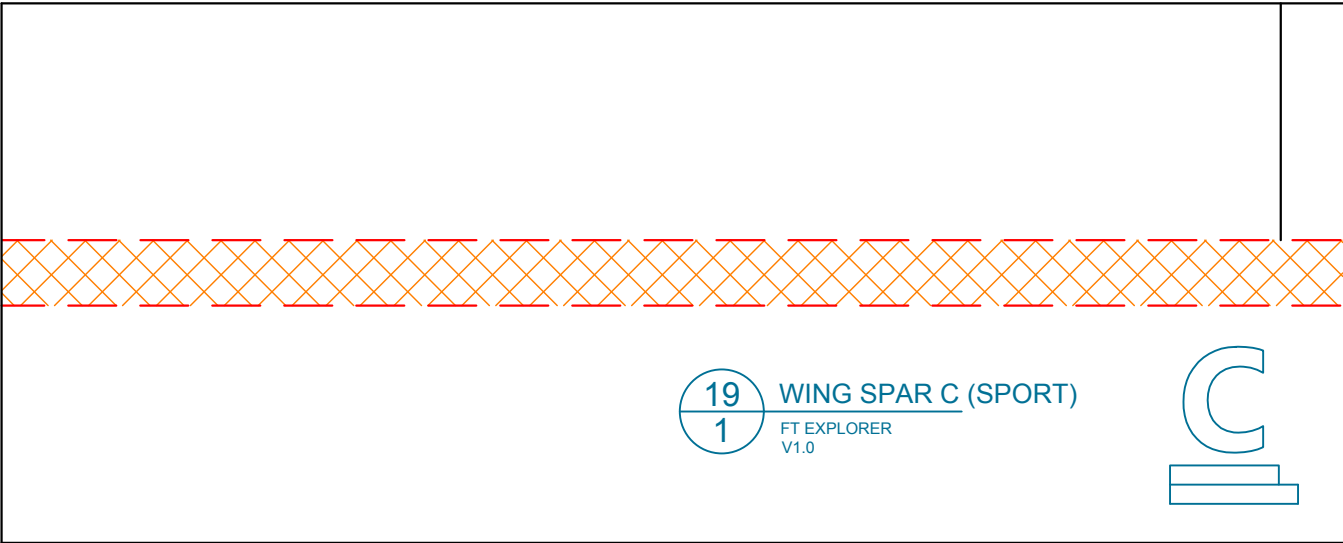
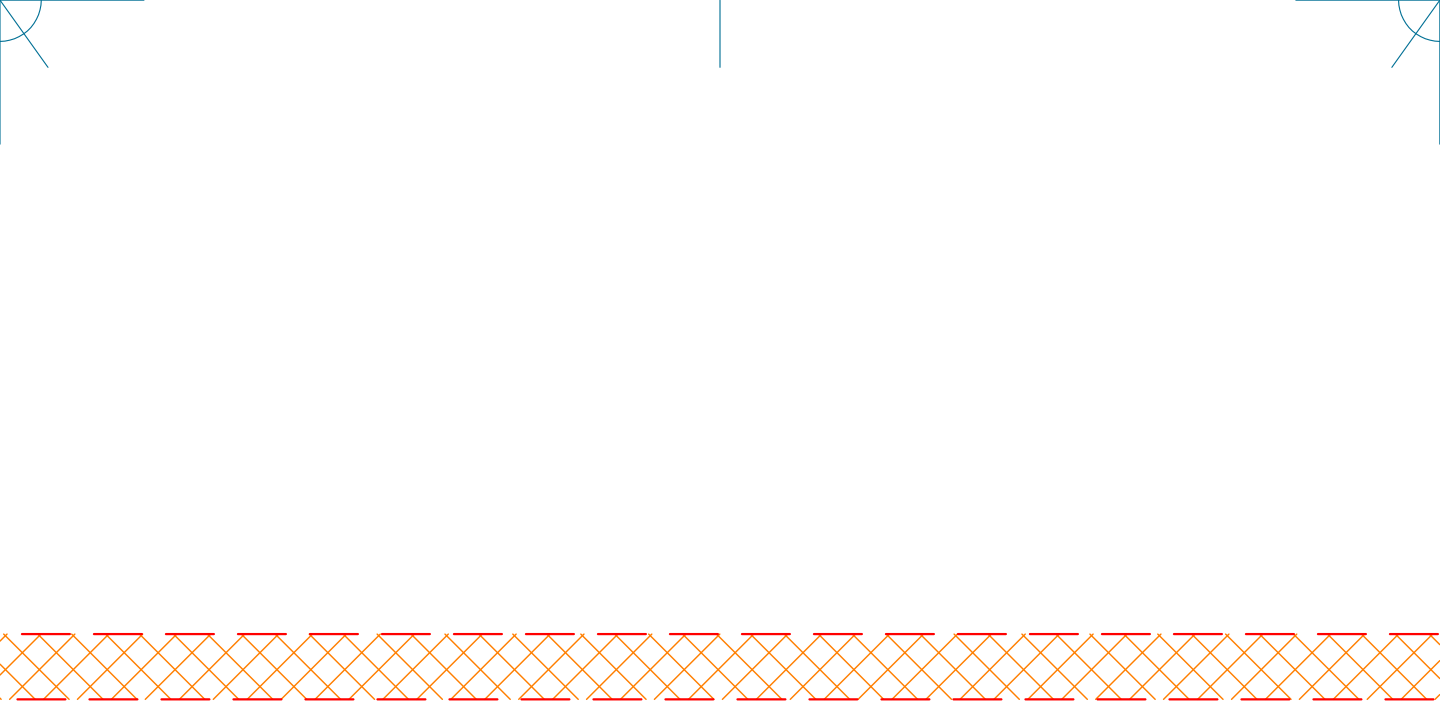

19
1

WING SPAR C (SPORT)

FT EXPLORER
V1.0



