



www.flitetest.com

FT Mini Mustang

Designed By: Josh Bixler
Drawing By: Dan Sponholz



SPECIFICATIONS

DESCRIPTION		IMPERIAL	METRIC
LENGTH		19 in	482 mm
CENTER OF GRAVITY	CG	1.00 in	25 mm
WING SPAN		24 in	622 mm
WING AREA		115 in ²	7.4 dm ²
DRY WEIGHT		5.5 oz	156 g
ALL UP WEIGHT	AUW	7.8 oz	222 g
WING LOADING	WL	9.8 oz/ft ²	29.9 g/dm ²
WING CUBIC LOADING	WCL	10.9	

RECOMMENDED SETTINGS

	THROW	EXPO
AILERON	12°	30%
ELEVATOR	12°	30%
RUDDER	12°	30%



SHEET & TILE KEY

1	2	3	4
5	6	7	8

9	10	11	12
13	14	15	16



DRAWING KEY

FOLD TYPES



A - FOLD (ABOVE)

B - FOLD (BESIDE)

C - FOLD (COVER)



LINE TYPE/COLOR

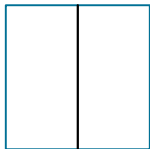

CUT

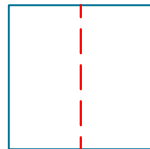

50% SCORE

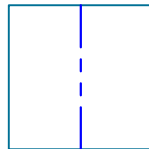

CREASE

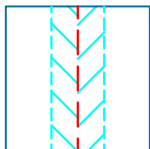

45° DOUBLE BEVEL

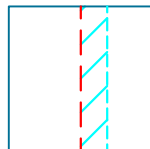

45° SINGLE BEVEL

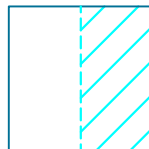

EDGE BEVEL

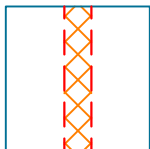

CAVITY

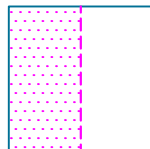

REMOVE PAPER

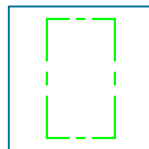

REFERENCE/
OPTIONAL



SYMBOLS

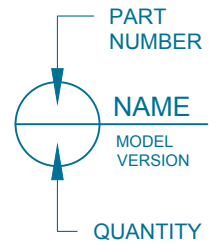

MIRRORED PART

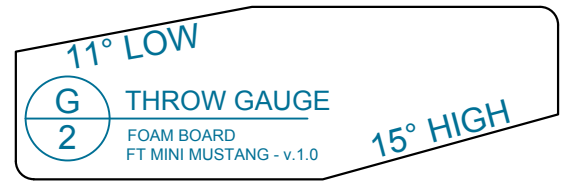
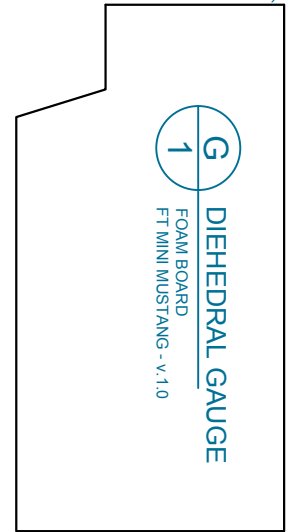
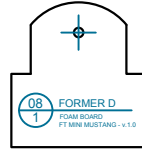
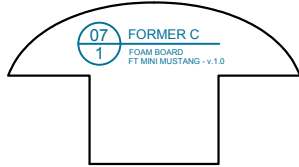
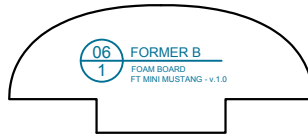
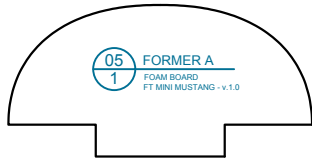

Firewall / Control Horns
1/16" (1.5mm) Thick
Hobby Grade Plywood

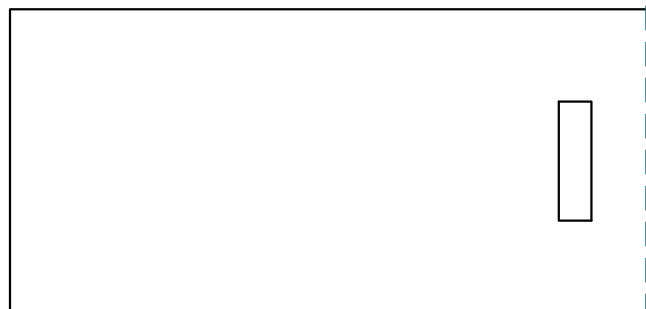
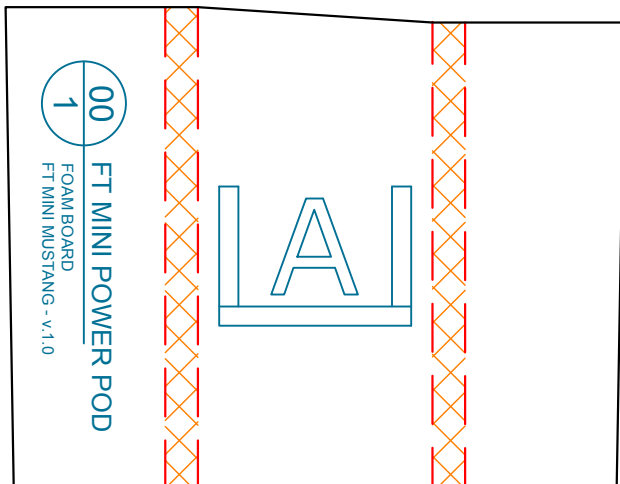
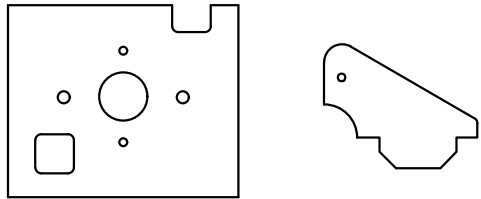

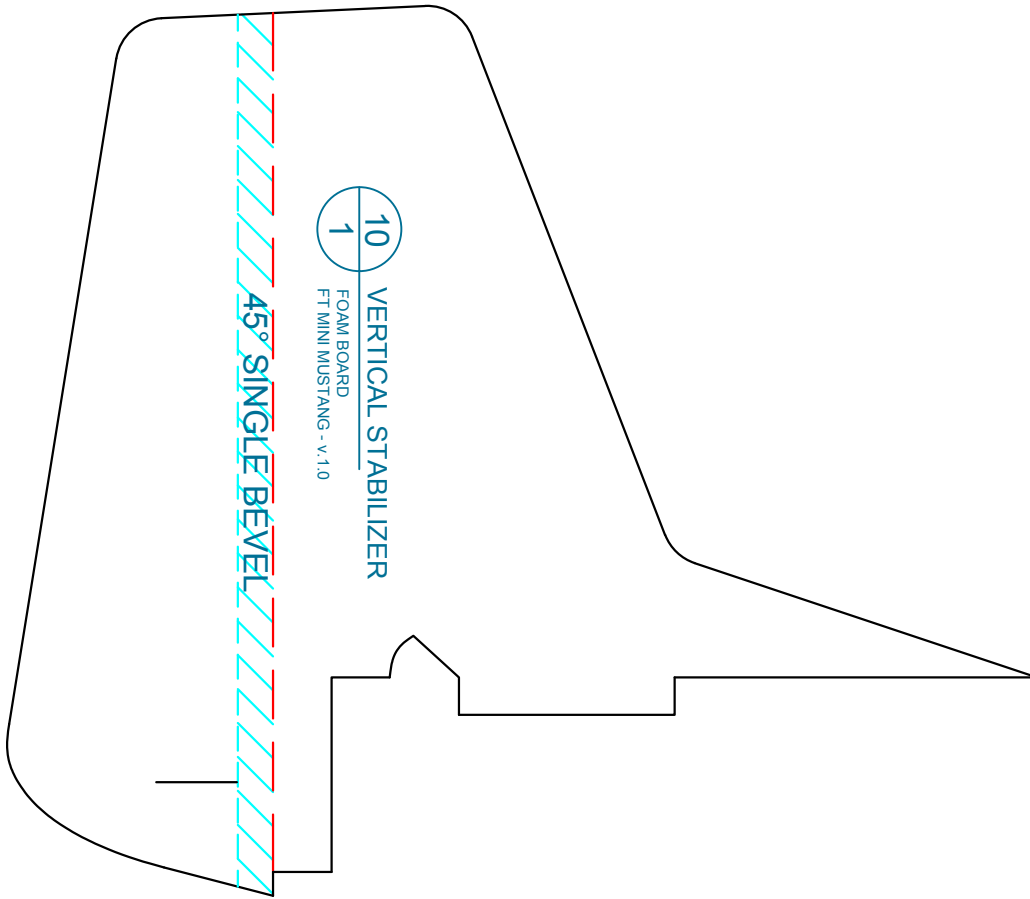

04
1
BATTERY HATCH
FOAM BOARD
FT MINI MUSTANG - v.1.0

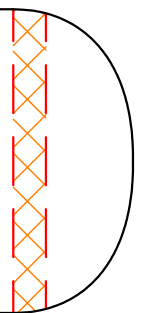
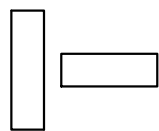

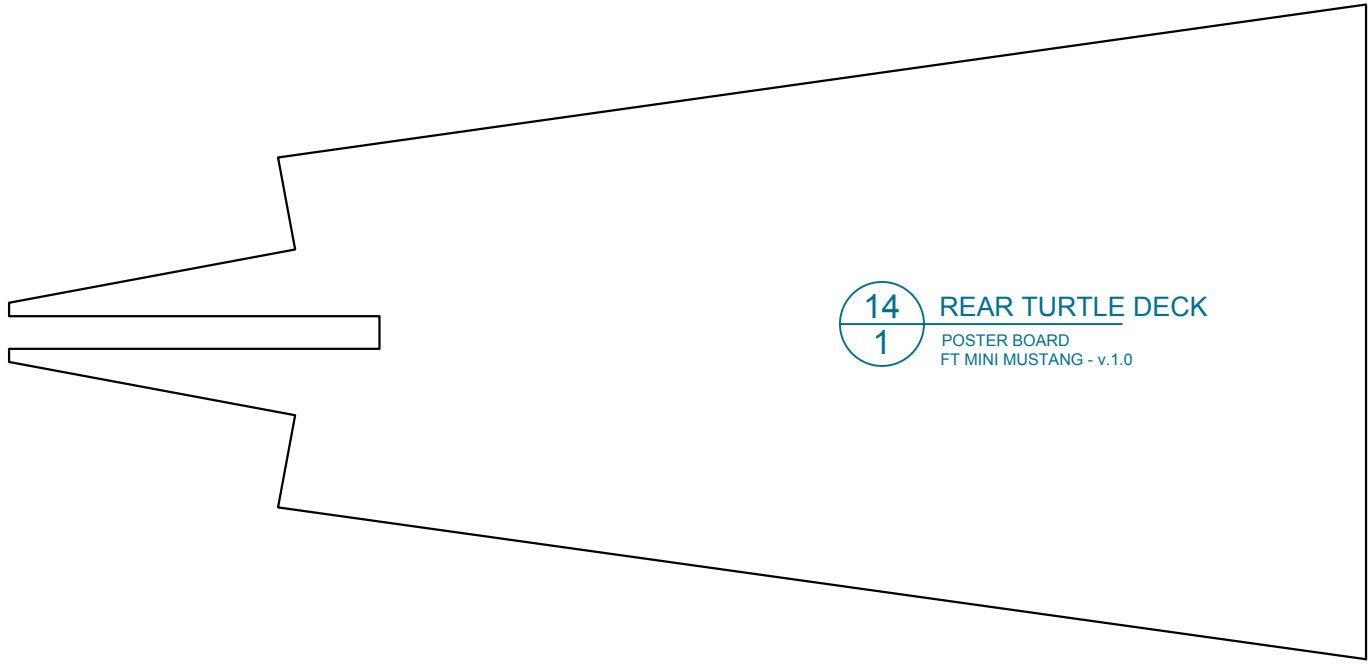

14
1

REAR TURTLE DECK

POSTER BOARD
FT MINI MUSTANG - v.1.0

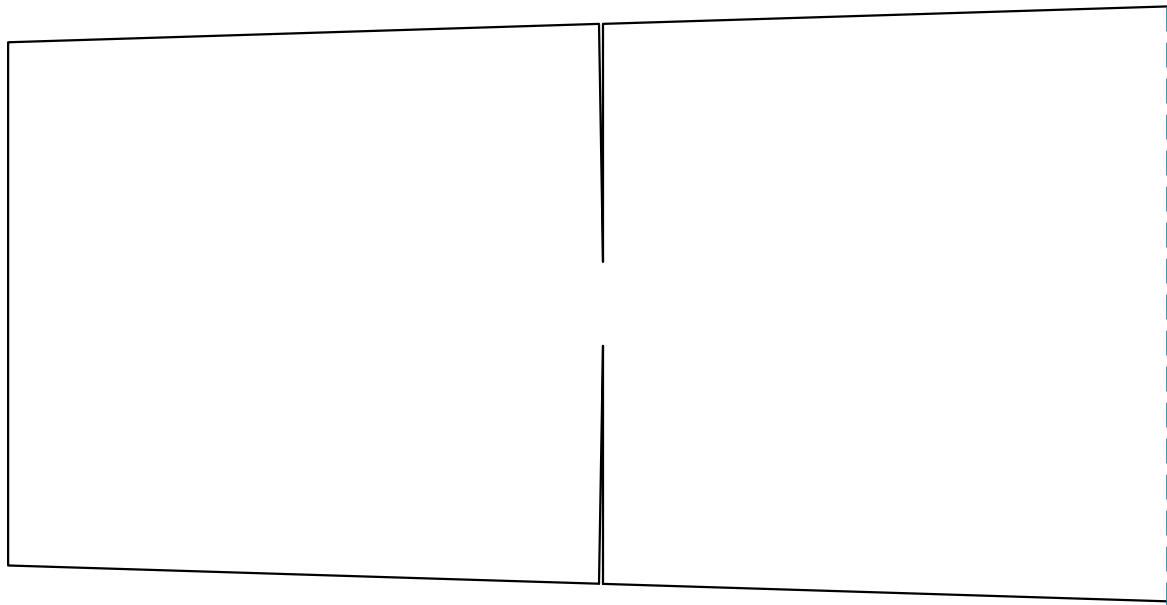

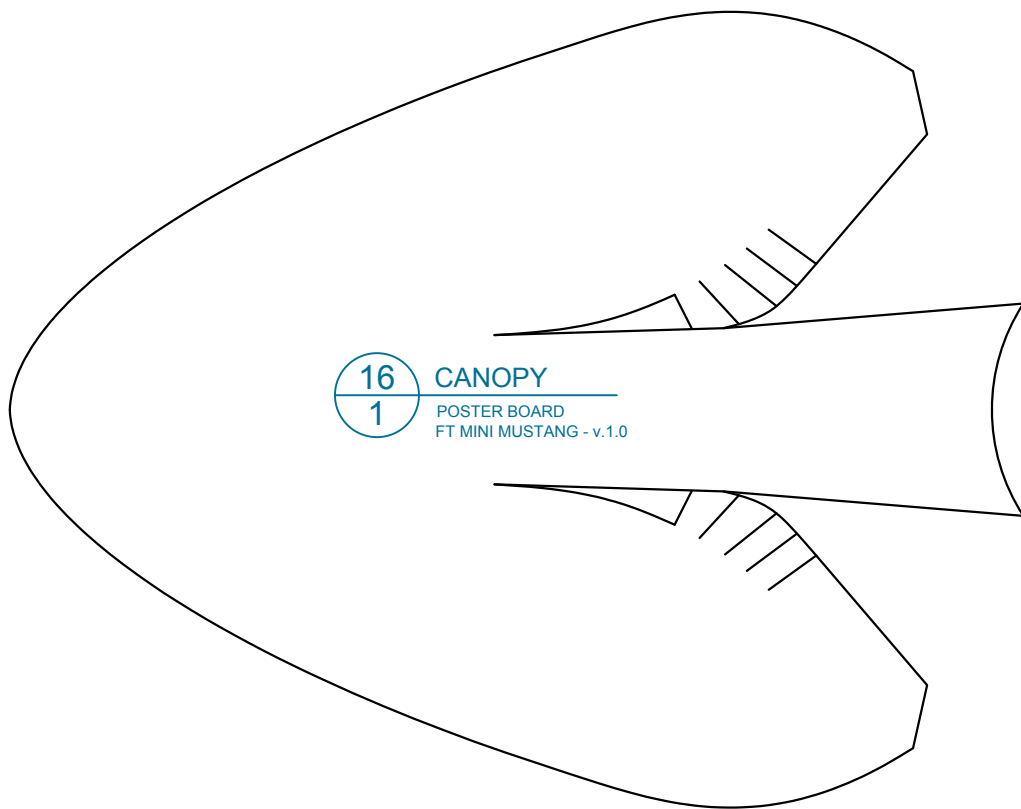

16
1 **CANOPY**
POSTER BOARD
FT MINI MUSTANG - v.1.0

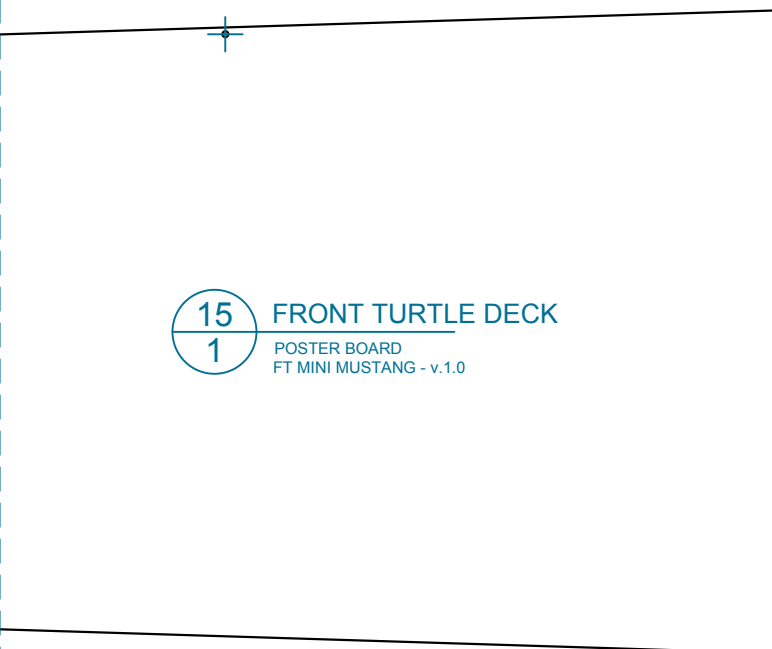

15
1 **FRONT TURTLE DECK**
POSTER BOARD
FT MINI MUSTANG - v.1.0

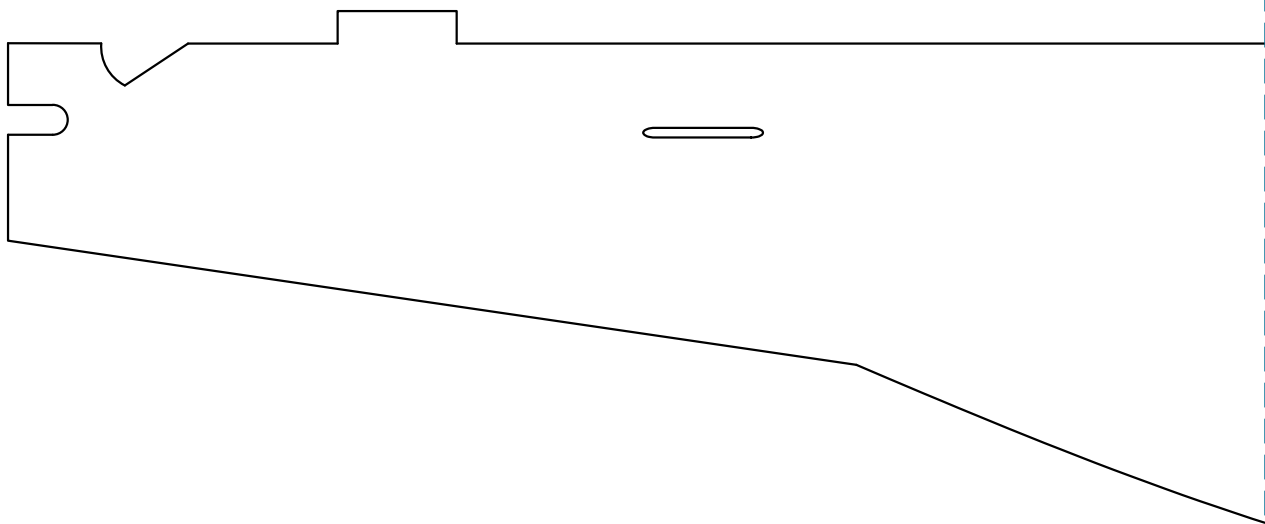
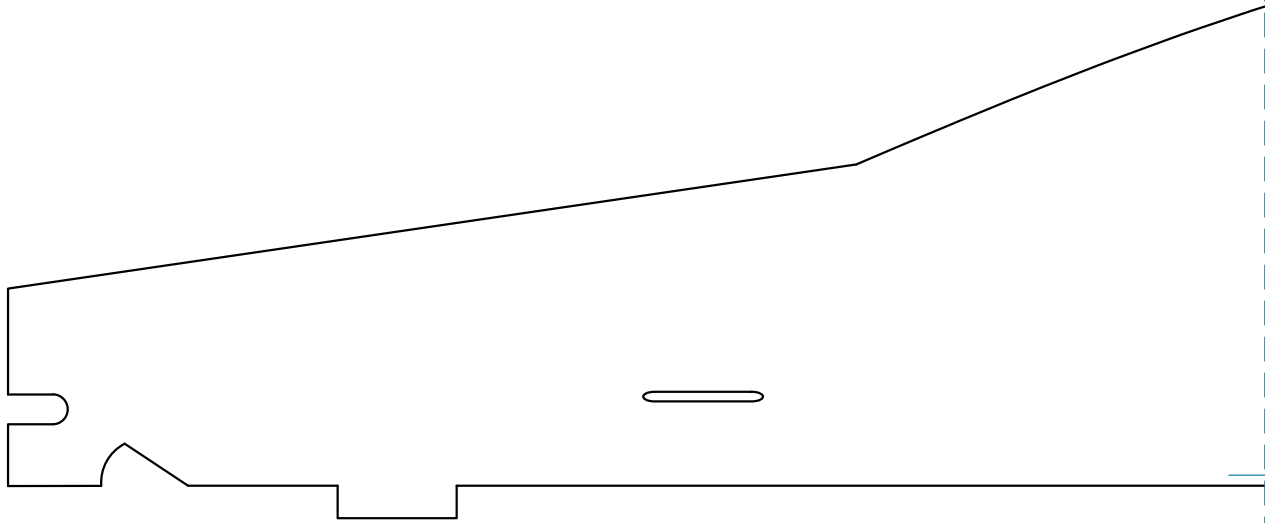
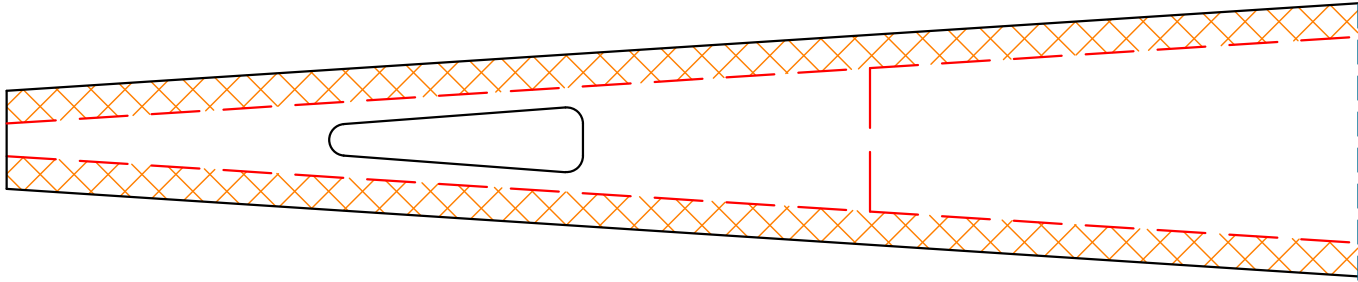

02
1

BOTTOM SHEETING A

FOAM BOARD
FT MINI MUSTANG - v.1.0

01
1

FUSELAGE

FOAM BOARD
FT MINI MUSTANG - v.1.0

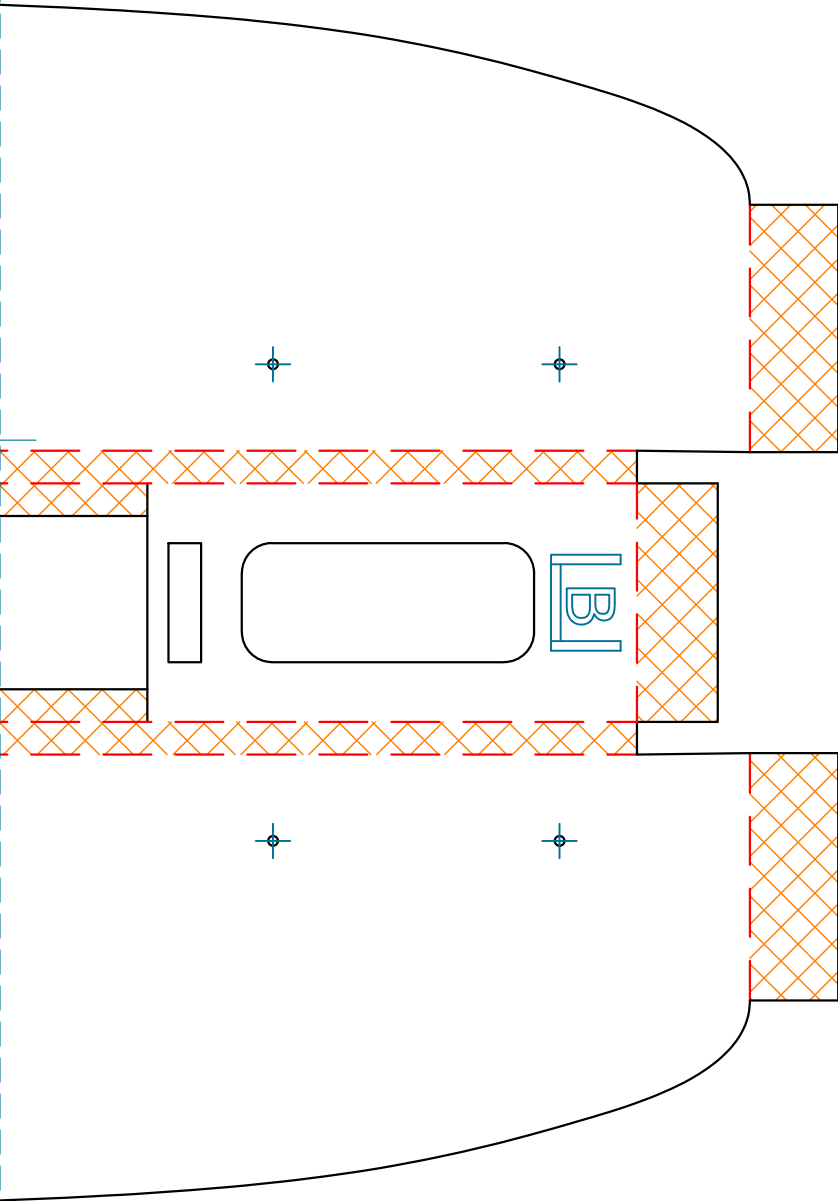

03 BOTTOM SHEETING B
1 FOAM BOARD
FT MINI MUSTANG - v.1.0

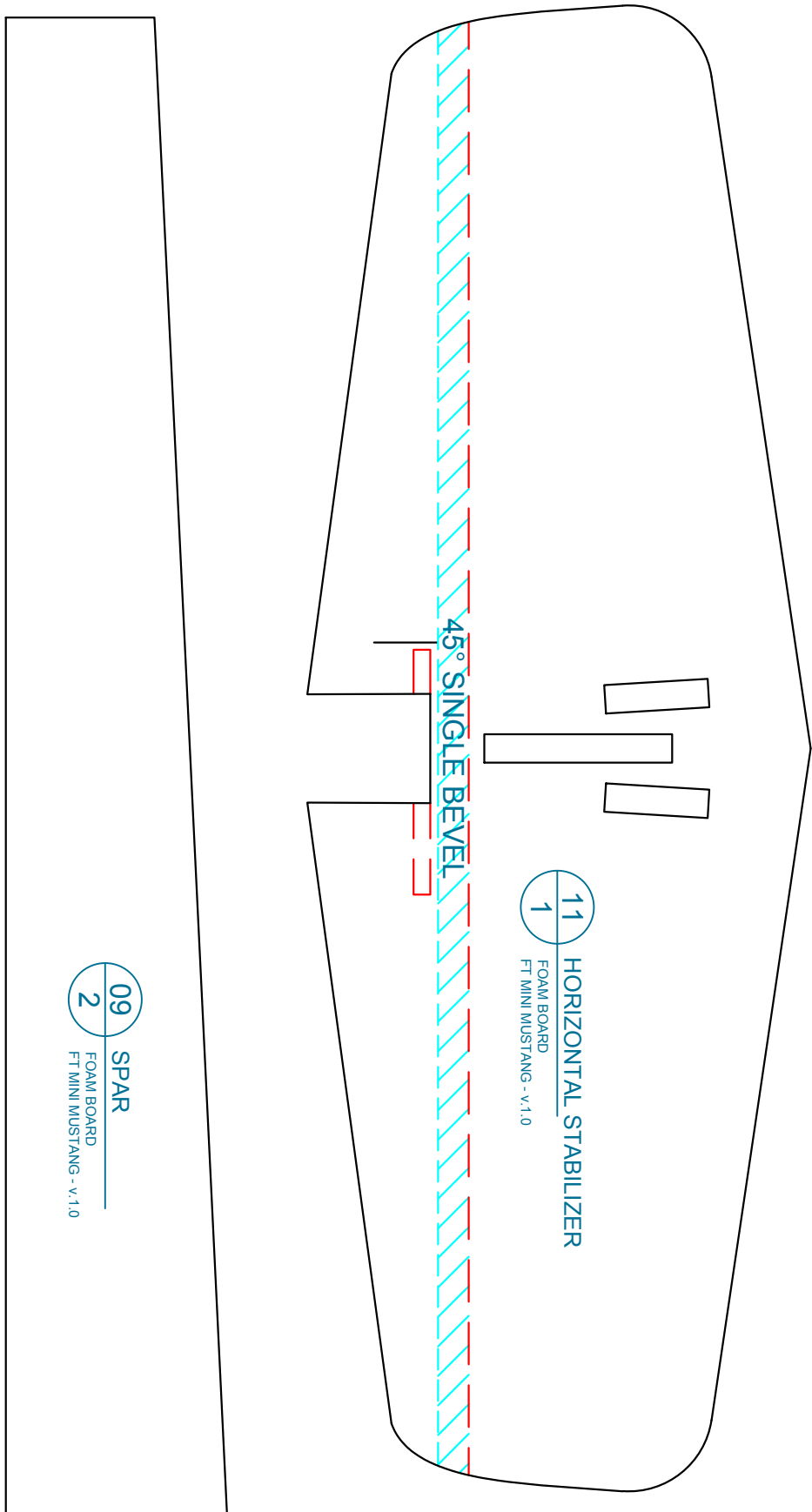

IN
CM

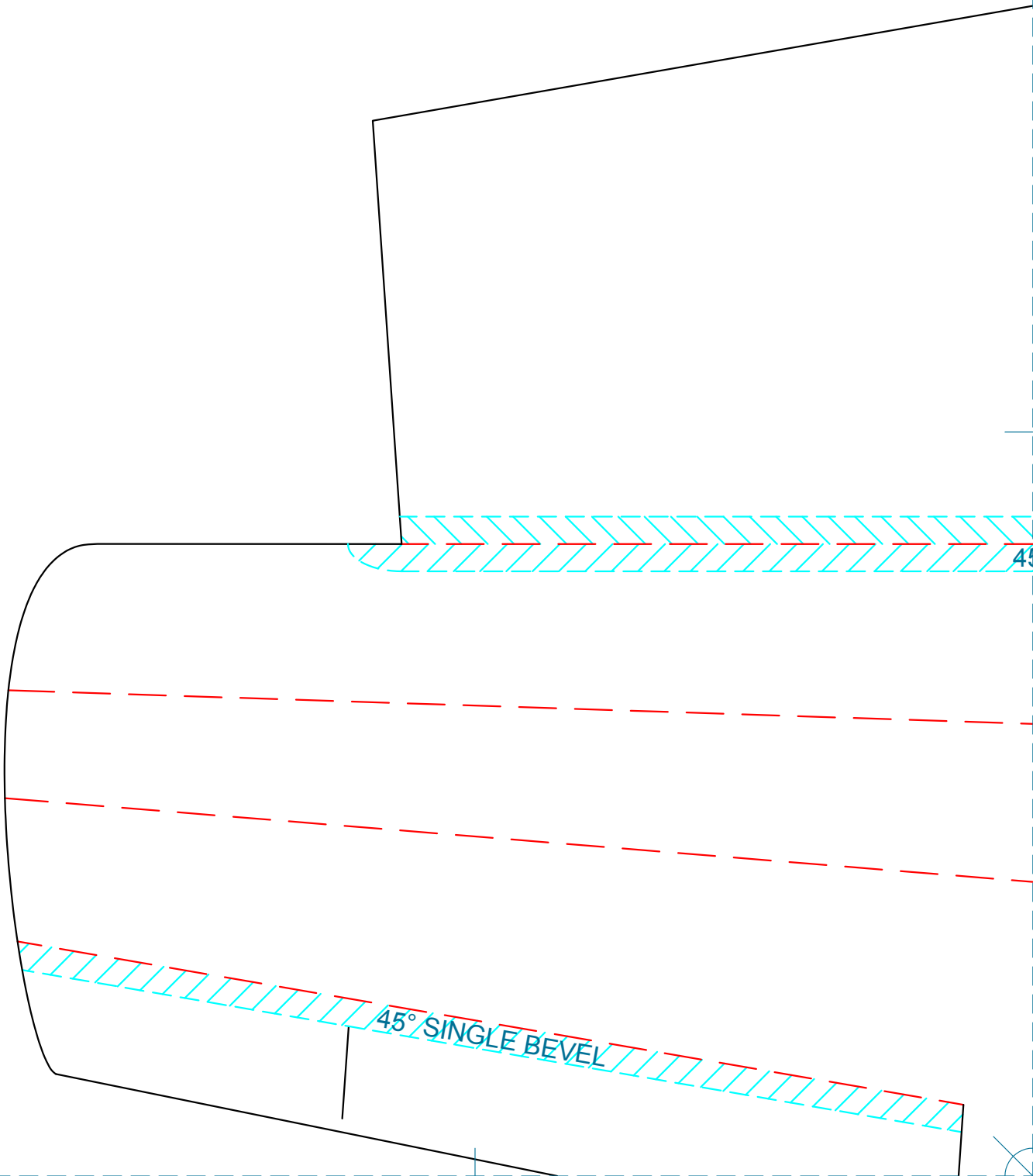

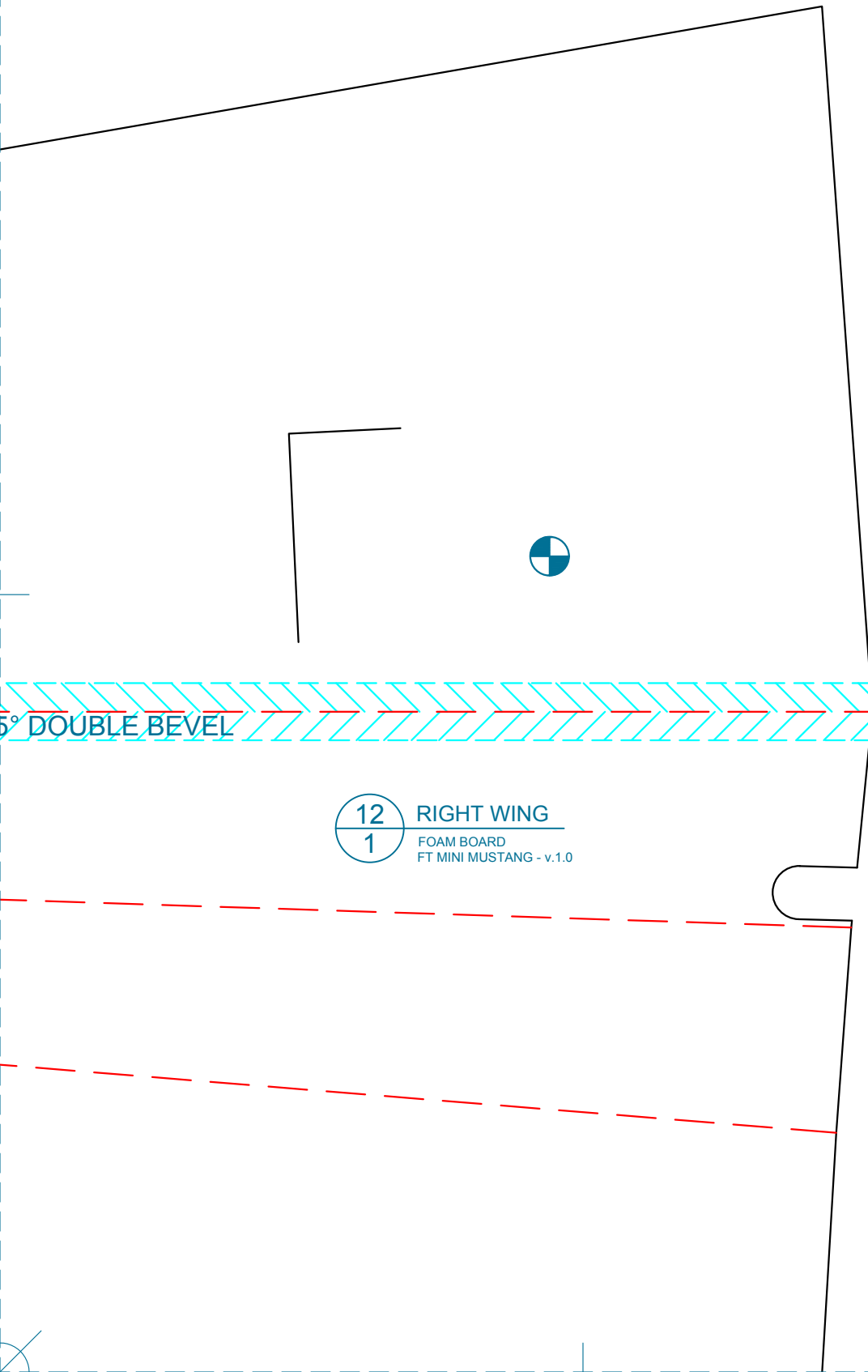

5° DOUBLE BEVEL

12
1

RIGHT WING
FOAM BOARD
FT MINI MUSTANG - v.1.0

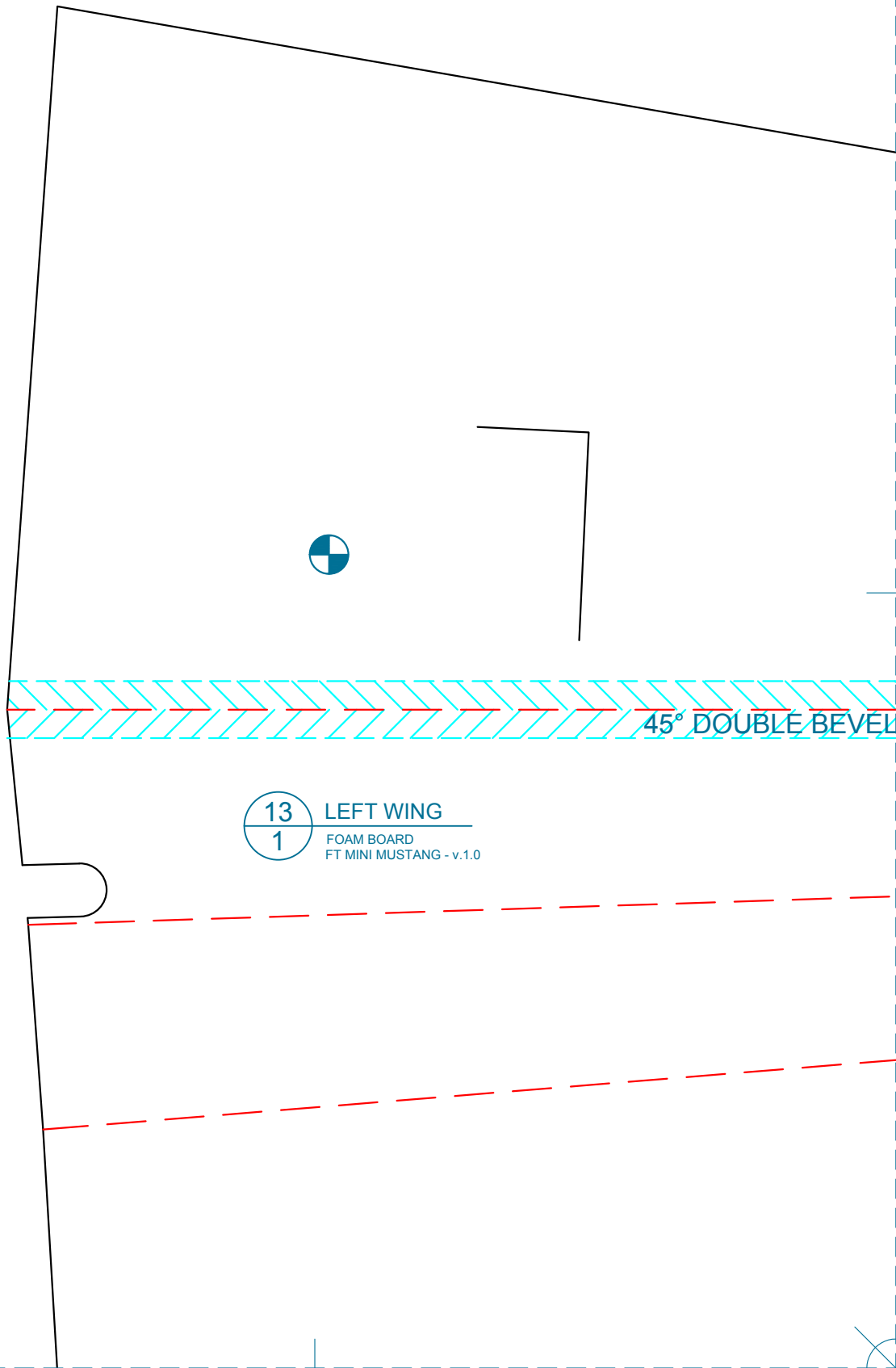

13 LEFT WING
1 FOAM BOARD
FT MINI MUSTANG - v.1.0

45° DOUBLE BEVEL

